



GATE | PSUs

INSTRUMENTATION ENGINEERING

Signals & Systems

**(Text Book: Theory with worked out Examples and
Practice Questions)**



Chapter 1

Introduction

(Solutions for Text Book Practice Questions)

01. Ans: (c)

Sol: The maximum value of

A. $x(n) + 2x(-n) = \{-1, -1, 3, 1, 1\}$ is 3

The maximum value of

B. $5x(n)x(n-1) = \{0, 5, 5, -5, 5, 0\}$ is 5

The maximum value of

C. $x(n)x(-n-1) = \{0, -1, 1, 1, -1, 0\}$ is 1

The maximum value of

D. $4x(2n) = \{4, 4, -4\}$ is 4

$B > D > A > C$

02. Ans: (a)

Sol:

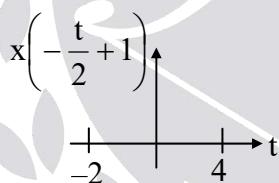
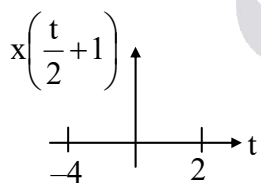
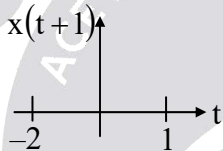
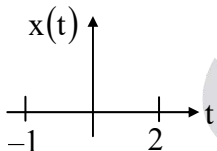

Non zero duration = 6

03.

Sol: Sifting property of impulse is

$$\int_{t_1}^{t_2} x(t)\delta(t-t_0)dt = x(t_0) \quad t_1 \leq t_0 \leq t_2$$

= 0 other wise

(a) $t_0 = 4$ is out of the limit so value = 0

(b) $(t + \cos\pi t)|_{t=1} = 0$

(c) $\cos t u(t-3)|_{t=0} = 1u(-3) = 0$

(d) $\frac{1}{2}e^{t-2} \Big|_{t=2} = \frac{1}{2}$

(e) $t \sin t \Big|_{t=\frac{\pi}{2}} = \frac{\pi}{2}$

04.

Sol: $x(n) = 1 - [\delta(n-4) + \delta(n-5) + \dots]$

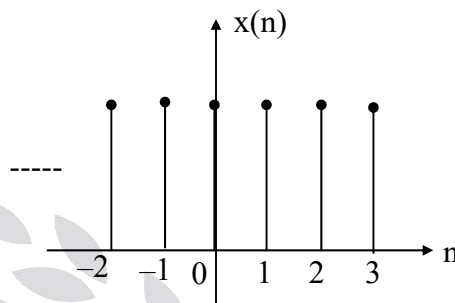

$x(n) = u(-n+3) = u(Mn - n_0)$

$M = -1 \quad n_0 = -3$

05.

Sol:

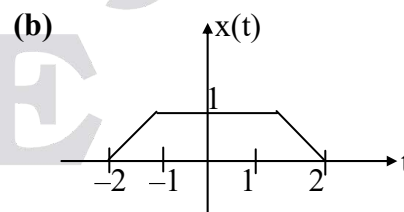
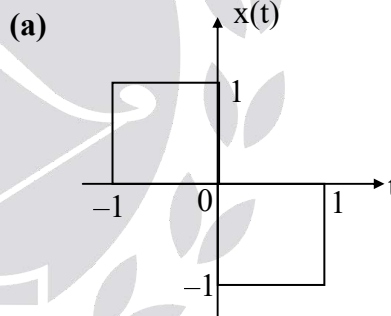

06.

Sol: (a) as $t \rightarrow \infty$, amp $\rightarrow 0$, Energy signal

(b) Constant amp – Power signal

(c) Power + energy = Power signal

(d) Periodic signal \rightarrow Power signal

(e) as $t \rightarrow \infty$, amp $\rightarrow \infty$, NENP

(f) as $t \rightarrow \infty$, amp $\rightarrow \infty$, NENP

07.

Sol:

(i)

$$E_{x_1(n)} = \sum_{n=-\infty}^{\infty} |x_1(n)|^2 = \sum_{n=0}^{\infty} (\alpha(0.5)^n)^2 = \sum_{n=0}^{\infty} \alpha^2 (0.25)^n$$

$$= \alpha^2 \sum_{n=0}^{\infty} (0.25)^n = \frac{\alpha^2}{1-0.25} = \frac{\alpha^2}{0.75}$$

$$E_{x_2(n)} = \sum_{n=-\infty}^{\infty} |x_2(n)|^2 = 1.5 + 1.5 = 3$$

Given $E_{x_1(n)} = E_{x_2(n)}$

$$\frac{\alpha^2}{0.75} = 3$$

$$\alpha^2 = 2.25$$

$$\alpha = 1.5$$

(ii) Ans: (a)

Sol: $x_1(t) = |t|; \quad -1 \leq t \leq 1$

$x_2(t) = 1 - |t|; \quad -1 \leq t \leq 1$

$T = 0.25$ secs

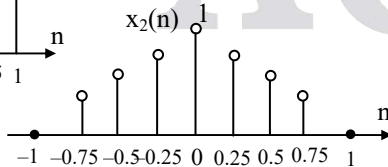
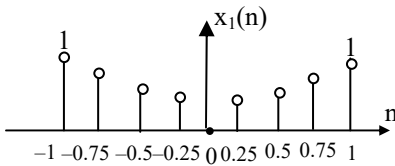
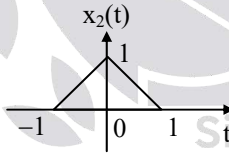
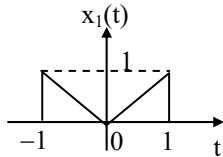

Energy in $x(n) = \sum_{n=-\infty}^{\infty} |x(n)|^2$

Energy of the first signal

$$= 2(1^2 + 0.75^2 + 0.5^2 + 0.25^2)$$

$$= 3.75$$

Energy of the secondary signal

$$= 1 + 2(0.75^2 + 0.5^2 + 0.25^2)$$

$$= 2.75$$

$$E_{x_1(n)} > E_{x_2(n)}$$

08.

Sol: $x_{oc}(n) = \frac{x(n) - x^*(-n)}{2}$

$$= \left[\frac{1+j7}{2}, 0, \frac{-1+j7}{2} \right]$$

09.

Sol:

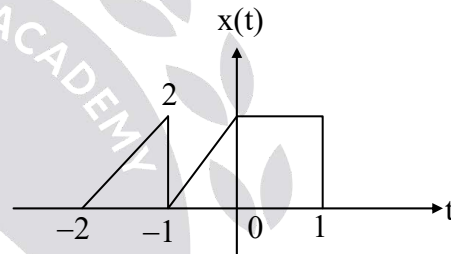

10.

Sol: (a) $T_1 = \frac{1}{9}, T_2 = \frac{1}{6}$

$$\frac{T_1}{T_2} = \frac{2}{3} \quad \text{LCM} = 3$$

$$T_0 = \text{LCM} \times T_1 = 1/3$$

(b) $T_1 = \frac{15}{11}, T_2 = 15$

$$\frac{T_1}{T_2} = \frac{1}{11}$$

$$\text{LCM} = 11$$

$$T_0 = \text{LCM} \times T_1 = 15$$

(c) $T_1 = \frac{2\pi}{3}, T_2 = \frac{2}{5}$

$$\frac{T_1}{T_2} = \frac{5\pi}{3} \quad \text{irrational number}$$

So a non-periodic.

(d) $T_0 = \frac{2\pi}{10} = \frac{\pi}{5}$

(e) It is extending from 0 to ∞
So non-periodic

(f) $x_e(t) = \frac{x(t) + x(-t)}{2} = \frac{1}{2} \cos 2\pi t$

$T_0 = \frac{2\pi}{\omega_0} = \frac{2\pi}{2\pi} = 1$

(g) $\frac{\omega_0}{2\pi} = \frac{5}{6}$ - rational, so periodic

$N_0 = \frac{2\pi}{\omega_0} m = \frac{6}{5} m$

$N_0 = 6$

(h) $N_1 = 8m \Rightarrow N_1 = 8$

$N_2 = 16m \Rightarrow N_2 = 16$

$N_3 = 4m \Rightarrow N_3 = 4$

$\frac{N_1}{N_2} = \frac{1}{2}, \frac{N_1}{N_3} = 2$

LCM = 2

$N_0 = \text{LCM} \times N_1 = 16$

(i) $\frac{\omega_0}{2\pi} = \frac{7}{2}$ - rational, so periodic

$N_0 = \frac{2\pi}{\omega_0} m = \frac{2}{7} m$

$N_0 = 2$

(j) multiplication of one periodic & non-periodic is non-periodic

(k) $u(n) + u(-n) = 1 + \delta(n)$ is non-periodic

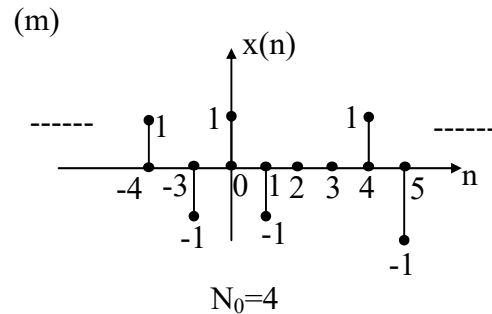
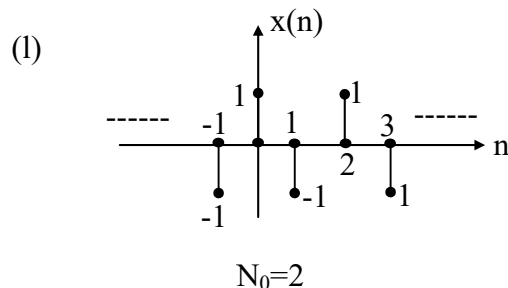

11. Sol:

(A) $x(nT_s) = 2\cos(150 \times \pi \times n \times T_s + 30^\circ)$
 $= 2\cos\left(\frac{3\pi}{4}n + 30^\circ\right)$

$\omega_0 = \frac{3\pi}{4}$

$N_0 = \frac{2\pi}{\omega_0} m = \frac{8}{3} m$

$N_0 = 8$

(B) Ans: (a)

$N_1 = \frac{2}{3} m \Rightarrow N_1 = 2$

$N_2 = \frac{2}{7} m \Rightarrow N_2 = 2$

$N_3 = \frac{20}{25} m \Rightarrow N_3 = 4$

$\frac{N_1}{N_2} = 1, \frac{N_1}{N_3} = \frac{1}{2}, \text{LCM} = 2$

$N_0 = \text{LCM} \times N_1 = 4$

$\omega_0 = \frac{2\pi}{4} = \frac{\pi}{2}$

$x(n) = \cos(6\omega_0 n) + \sin(14\omega_0 n) + \cos(5\omega_0 n)$
so 14th harmonic.

(C)

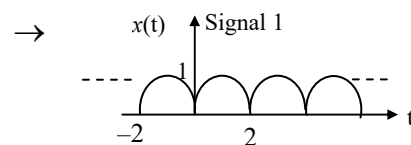

$$T = 2 \text{ sec}$$

$$x(t) = 1 \cdot \sin \frac{\pi}{2} t \quad 0 \leq t \leq 2$$

$$\text{Average value} = \frac{\int_0^2 \sin \frac{\pi}{2} t \, dt}{2}$$

$$= -\left(\cos \frac{\pi}{2} t\right)_0^2$$

$$= -\frac{\pi}{2}(2)$$

$$= -\frac{(\cos \pi - \cos 0)}{\pi}$$

$$= \frac{2}{\pi}$$

$$x_{\text{avg}} = \frac{2}{\pi}$$

Energy in one period

$$= \int_0^2 \sin^2 \frac{\pi}{2} t \, dt$$

$$= \int_0^2 \left(\frac{1 - \cos \pi t}{2}\right) dt$$

$$= \left[\frac{1}{2}t - \frac{\sin \pi t}{2\pi}\right]_0^2 = 1\text{J}$$

$$\text{Signal power} = \frac{\text{Energy in one period}}{\text{Time period}}$$

$$= \frac{1}{2} \text{ W}$$

$$\text{RMS value} = \sqrt{P_{\text{avg}}}$$

$$= \frac{1}{\sqrt{2}}$$

→

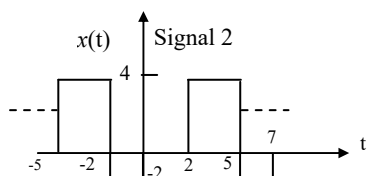

$$T = 7 \text{ sec}$$

$$\text{Average value} = \frac{\int_0^2 0 \, dt + \int_2^5 4 \, dt + \int_5^7 -2 \, dt}{7}$$

$$= \frac{12 - 4}{7}$$

$$= \frac{8}{7}$$

Energy in one period

$$= \int_0^2 0^2 \, dt + \int_2^5 4^2 \, dt + \int_5^7 (-2)^2 \, dt$$

$$= 16 \times 3 + 4 \times 2$$

$$= 56\text{J}$$

$$\text{Signal power} = \frac{\text{Energy in one period}}{\text{Time period}}$$

$$= \frac{56}{7}$$

$$= 8\text{W}$$

$$\text{RMS value} = \sqrt{P_{\text{avg}}} = \sqrt{8}$$

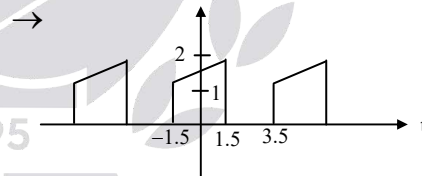

$$T = 5 \text{ sec}$$

$$x(t) = \begin{cases} \frac{1}{3}(t + 4.5), & -1.5 \leq t \leq 1.5 \\ 0, & 1.5 < t < 3.5 \end{cases}$$

Average value

$$= \frac{\text{Area of rectangle} + \text{Area of Triangle}}{5}$$

$$= \frac{3(1) + \frac{1}{2}(3)(1)}{5}$$

$$= 0.9$$

Energy in one period

$$\begin{aligned}
 &= \int_{-1.5}^{1.5} \left(\frac{1}{3}(t+4.5) \right)^2 dt \\
 &= \frac{1}{9} \int_{-1.5}^{1.5} (t+4.5)^2 dt \\
 &= \frac{1}{9} \left[\frac{(t+4.5)^3}{3} \right]_{-1.5}^{1.5} = 7J
 \end{aligned}$$

$$P_{\text{avg}} = \frac{7}{5} = 1.4W$$

$$\text{RMS} = \sqrt{1.4}$$

12.

Sol: (a) $[x_1(t) + x_2(t)][x_1(t-2) + x_2(t-2)]$
 $\neq x_1(t)x_1(t-2) + x_2(t)x_2(t-2)$
 is non linear

(b) $\sin[x_1(t) + x_2(t)] \neq \sin[x_1(t)] + \sin[x_2(t)]$
 is non linear

(c) $\frac{d}{dt} [\alpha x_1(t) + \beta x_2(t)] = \frac{\alpha dx_1(t)}{dt} + \frac{\beta dx_2(t)}{dt}$
 is linear

(d) $2[x_1(t) + x_2(t)] + 3 \neq 2[x_1(t) + x_2(t)] + 6$
 is non linear

(e) $\int_{-\infty}^t [\alpha x_1(\tau) + \beta x_2(\tau)] d\tau$
 $= \alpha \int_{-\infty}^t x_1(\tau) d\tau + \beta \int_{-\infty}^t x_2(\tau) d\tau$ is linear

(f) $[x_1(t) + x_2(t)]^2 \neq x_1^2(t) + x_2^2(t)$
 is non linear

(g) $[\alpha x_1(t) + \beta x_2(t)] \cos \omega_0 t$
 $= \alpha x_1(t) \cos \omega_0 t + \beta x_2(t) \cos \omega_0 t$ is linear

(h) $\log[x_1(n) + x_2(n)] \neq \log[x_1(n)] + \log[x_2(n)]$
 is non linear

(i) $|x_1(n) + x_2(n)| \neq |x_1(n)| + |x_2(n)|$
 is non linear

(j) $\alpha^* x^*(n) \neq \alpha x^*(n)$ is non linear

(k) non linear (median is a non linear operator)

(l) $\frac{x_1(n) + x_2(n)}{x_1(n-1) + x_2(n-1)} \neq \frac{x_1(n)}{x_1(n-1)} + \frac{x_2(n)}{x_2(n-1)}$
 is non linear

(m) linear (no non linear operator is present)

(n) $e^{x_1(n) + x_2(n)} \neq e^{x_1(n)} + e^{x_2(n)}$ is non linear

13.

Sol: (a) $tx(t-t_0) + 3 \neq (t-t_0)x(t-t_0) + 3$
 time variant

(b) $e^{x(t-t_0)} = e^{x(t-t_0)}$ time invariant

(c) $x(t-t_0) \cos 3t \neq x(t-t_0) \cos 3(t-t_0)$
 time variant

(d) $\sin [x(t-t_0)] = \sin [x(t-t_0)]$ time invariant

(e) $\frac{d[x(t-t_0)]}{d(t-t_0)} = \frac{dx(t-t_0)}{dt - dt_0} = \frac{d}{dt} [x(t-t_0)]$
 time invariant

(f) $x^2(t-t_0) = x^2(t-t_0)$ time invariant

(g) $x(2t-t_0) \neq x(2t-2t_0)$ time variant

(h) $2^{x(n-n_0)} x(n-n_0) = 2^{x(n-n_0)} x(n-n_0)$
 time invariant

(i) time variant (time reversal operation is time variant)

(j) time variant (coefficient is time variable)

(k) all coefficients are constant
 - time invariant

14.

Sol: $x_2(t) = x_1(t) - x_1(t-2)$

$y_2(t) = y_1(t) - y_1(t-2)$

$x_3(t) = x_1(t+1) + x_1(t)$

$y_3(t) = y_1(t+1) + y_1(t)$

15.
Sol: (a) Present output depends on present input-causal

(b) present output depends on present input-causal

(c) present output depends on present input-causal

 (d) present output depends on future input-non causal ($y(-\pi) = x(0)$)

(e) present output depends on present input-causal

(f) present output depends on present input-causal

 (g) $n > n_0$ causal, $n < n_0$ non-causal

(h) non-causal (present output depends on future input)

 (i) $y(0) = \sum_{k=-\infty}^0 x(k)$ present output depends on present input - causal

 (j) $y(-1) = \sum_{k=0}^{-1} x(k)$ future input non causal

(k) non-causal for any value of 'm'

 (l) $\alpha = 1$ causal, $\alpha \neq 1$ non causal

(m) causal (present output depends on past inputs)

(n) non causal (present output depends on future input)

16.
Sol: (a) present output depends on present input -static

(b) present output depends on present input -static

(c) present output depends on present input -static

(d) present output depends on present input -static

 (e) $y(1) = x(3)$ present output depends on future input -dynamic

(f) dynamic (differentiation operation is dynamic)

(g) present output depends on past input - dynamic

17.
Sol: If a system expressed with differential equation then it is dynamic.

The coefficients of differential equation are function of time then it is time variant.

(a) linear, time variant, dynamic

(b) linear, time invariant, dynamic

(c) linear, time invariant, dynamic

(d) non linear, time variant, dynamic

18.
Sol: If a system expressed with differential equation then it is dynamic.

The coefficients of differential equation are function of time then it is time variant.

(a) linear, time invariant, dynamic (a→2)

(b) non linear, time variant, static (b→5)

(c) linear, time variant, dynamic (c→1)

(d) nonlinear, time invariant, dynamic (d→4)

19.
Sol: (a) $y(t) = u(t).u(t) = u(t)$ - stable

 (b) $y(t) = \cos 3t u(t) \Rightarrow -1 < y(t) < 1$ stable

 (c) $y(t) = u(t-3)$ stable

(d) $y(t) = \frac{du(t)}{dt} = \delta(t)$ unstable

(e) $y(t) = \int_{-\infty}^t u(\tau) d\tau \Rightarrow r(t)$ is unstable

(f) $\sin(\text{finite}) = \text{finite}$. stable

(g) $y(t) = tu(t) = r(t)$ unstable

(h) $y(n) = e^{\text{finite}} = \text{finite}$ stable

(i) $y(n) = u(3n)$ bounded stable

(j) $x(n) = 1 \Rightarrow y(n) = n - n_0 + 1 \Rightarrow y(\infty) = \infty$
 \Rightarrow unstable

20.

Sol: Two different inputs produces same output then it is non invertible.

Two different inputs produces two different outputs then it is invertible.

(a) $x_1(t) = u(t) \Rightarrow y_1(t) = u(t)$

$x_2(t) = -u(t) \Rightarrow y_2(t) = u(t)$

So, non invertible

(b) $x_1(t) = u(t) \Rightarrow y_1(t) = u(t)$

$x_2(t) = -u(t) \Rightarrow y_2(t) = u(t)$

So, non invertible

(c) $x_1(t) = u(t) \Rightarrow y_1(t) = u(t-3)$

$x_2(t) = -u(t) \Rightarrow y_2(t) = -u(t-3)$

So, invertible

(d) $x_1(t) = A \Rightarrow y_1(t) = 0$

$x_2(t) = -A \Rightarrow y_2(t) = 0$

So, non invertible

(e) $x_1(n) = \delta(n) \Rightarrow y_1(n) = 0$

$x_2(n) = -\delta(n) \Rightarrow y_2(n) = 0$

So, non invertible

(f) $x_1(n) = \delta(n) \Rightarrow y_1(n) = 0$

$x_2(n) = -\delta(n) \Rightarrow y_2(n) = 0$

So, non invertible

(g) So, non invertible

(h) $x_1(n) = \delta(n) \Rightarrow y_1(n) = u(n)$

$x_2(n) = -\delta(n) \Rightarrow y_2(n) = -u(n)$

So, invertible

21.

Sol: Given

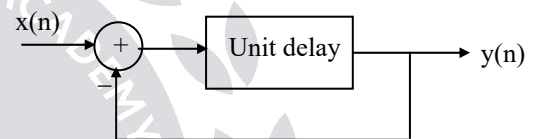

Convert to Z-domain

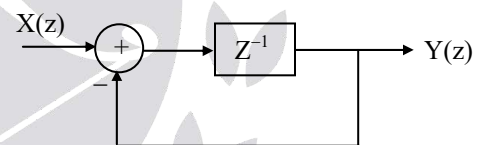

$$\frac{Y(z)}{X(z)} = \frac{z^{-1}}{1+z^{-1}} = \frac{1}{z+1}$$

(i) $x(n) = \delta(n)$;

$$\Rightarrow Y(z) = \frac{1}{z+1} X(z)$$

$$Y(z) = \frac{1}{z+1} \cdot 1 = \frac{1}{z+1}$$

$$Y(z) = z^{-1} \frac{z}{z+1}$$

Taking inverse Z - transform

$$y(n) = (-1)^{n-1} u(n-1)$$

if $n = 0, 1, 2, 3, \dots$

Then $y(n) = [0, 1, -1, 1, -1, \dots]$

(ii) $x(n) = u(n)$;

$$\Rightarrow Y(z) = \frac{1}{z+1} X(z)$$

$$Y(z) = \frac{1}{z+1} \frac{z}{z-1}$$

$$\frac{Y(z)}{z} = \frac{1}{(z+1)(z-1)} = \frac{A}{z+1} + \frac{B}{z-1}$$

$$= \frac{-\frac{1}{2}}{z+1} + \frac{\frac{1}{2}}{z-1}$$

$$Y(z) = -\frac{1}{2} \frac{z}{z+1} + \frac{1}{2} \frac{z}{z-1}$$

$$y(n) = -\frac{1}{2} (-1)^n u(n) + \frac{1}{2} u(n)$$

22. Ans: (a, b & d)

Sol: (a) True ex: $[e^t u(-t)] [e^{-t} u(t)] = 0$

(b) True ex: $[u(t)] [e^{-t} u(t)] = e^{-t} u(t)$
 $[u(-t)] [e^t u(t)] = 0$

(c) False
ex:

$$tu(t) - (t-1)u(t-1)$$

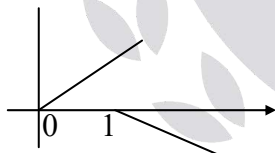

↓



(d) True

23. Ans: (a, b & c)

Sol:

- (a) True
- (b) True
- (c) True
- (d) False - Nonlinear system

24. Ans: (b)

Sol: Constant added - non linear

So, statement-I is true.

Time varying term - time variant

So, statement-II is true.

Both Statement I and Statement II are individually true but Statement II is not the correct explanation of Statement I.

25. Ans: (d)

Sol: (S-I): $y(n) = 2x(n) + 4x(n-1)$

If $x(n)$ is bounded, $y(n)$ is bounded.

∴ Stable. (S-I) is false.

(S-II): $h(n) = 2\delta(n) + 4\delta(n-1)$

$$h(n) = \{ 2, 4 \}$$

↑

Impulse response $h(n)$ has only two finite nonzero samples. This is the condition for stability.

∴ (S-II) is True.

Statement I is false but Statement II is true.

26. Ans: (a)

Sol: A system is memory less if output, $y(t)$ depends only on $x(t)$ and not on past or future values of input, $x(t)$.

A system is causal if the output, $y(t)$ at any time depends only on values of input, $x(t)$ at that time and in the past.

Both (S-I) and (S-II) are true and (S-II) is the correct explanation of (S-I).

Both Statement I and Statement II are individually true and Statement II is the correct explanation of Statement I.

Chapter 2 LTI (LSI) Systems

01.

Sol:

$$(a) y(t) = \int_{-\infty}^{\infty} x(\tau)h(t-\tau)d\tau$$

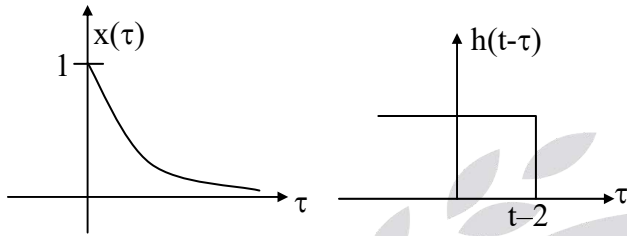

Case (i) $t-2 < 0$ $y(t) = 0, t < 2$

Case (ii) $t-2 > 0$ $y(t) = \int_0^{t-2} e^{-3\tau} d\tau = \frac{1-e^{-3(t-2)}}{3}, t > 2$

$$y(t) = \frac{1-e^{-3(t-2)}}{3} u(t-2)$$

(b)

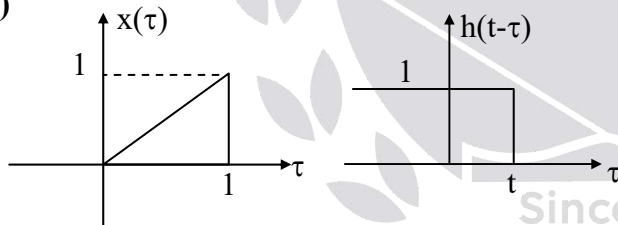

Case (i) $t < 0$ $y(t) = 0$

Case (ii) $0 < t < 1$ $y(t) = \int_0^t \tau d\tau = \frac{t^2}{2}$

Case (iii) $t > 1$ $y(t) = \int_0^1 \tau d\tau = \frac{1}{2}$

02. Ans: (b)

Sol: $x(t) * h(t) = \int_{-\infty}^{\infty} x(\tau)h(t-\tau)dt = y(t)$

$$y(2) = \int_{-\infty}^{\infty} x(\tau)h(2-\tau)d\tau$$

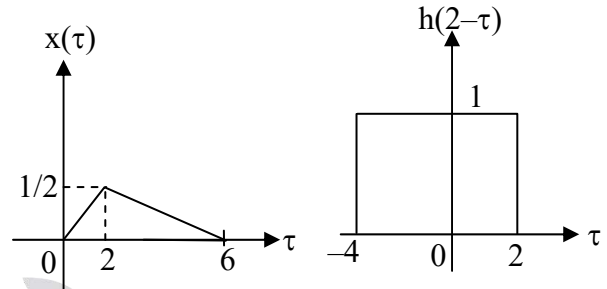

$$y(2) = \int_0^2 \left(\frac{\tau}{4}\right) 1 d\tau = \frac{\tau^2}{8} \Big|_0^2 = \frac{1}{2}$$

03.

Sol:

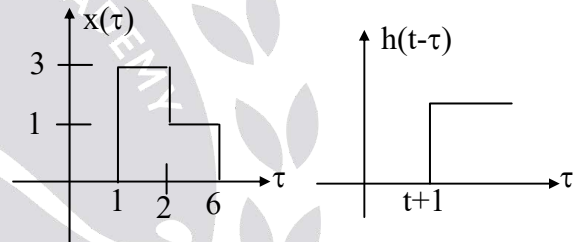

$$y(4) = \int_1^2 1 d\tau = 1$$

$$y\left(\frac{1}{2}\right) = \int_{1.5}^6 x(\tau)h\left(\frac{1}{2}-\tau\right) d\tau = \frac{3}{2} + 4 = 5.5$$

04. Ans: (b)

Sol: $s(t) = \int_{-\infty}^t h(\tau) d\tau = u(t-1) + u(t-3)$
 $s(2) = 1$

05.

Sol: Assume $-\tau + a = \lambda \Rightarrow -d\tau = d\lambda$
 $z(t) = \int_{-\infty}^{\infty} x(\lambda)h(t+a-\lambda)d\lambda = y(t+a)$

06.

Sol: (a) $x(t-7+5) = x(t-2)$
 (b) $x(t) * \frac{1}{|a|} \delta\left(t + \frac{b}{a}\right) = \frac{1}{|a|} x\left(t + \frac{b}{a}\right)$
 (c) $x(t) * [2\delta(t+3) + 2\delta(t-3)] = 2x(t+3) + 2x(t-3)$

07.

Sol:

(a) $e^{-1}u(1)\delta(t-1) = e^{-1}\delta(t-1)$

[From product property]

(b) $e^{-t}|_{t=1} = e^{-1}$ [From sifting property]

(c) $e^{-(t-1)}u(t-1)$ [From convolution property]

08.

Sol:

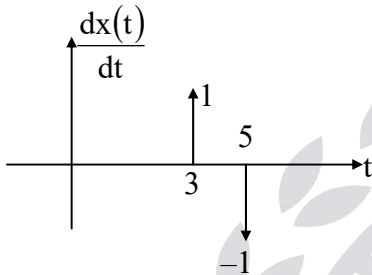

$$\frac{dx(t)}{dt} = \delta(t-3) - \delta(t-5)$$

$$\frac{dx(t)}{dt} * h(t) = h(t-3) - h(t-5)$$

09.

Sol: (a) $A_x A_h = A_y$,

$$\int_{-\infty}^{\infty} \delta(\alpha t) dt = \frac{1}{\alpha}$$

$$\frac{1}{\alpha} \cdot \frac{1}{\alpha} = \frac{A}{\alpha}$$

$$A = \frac{1}{\alpha}$$

(b) $\frac{1}{\alpha} \cdot \frac{1}{\alpha} = \frac{A}{\alpha}$,

$$\int_{-\infty}^{\infty} \text{sinc}(\alpha t) dt = \frac{1}{\alpha}$$

$$A = \frac{1}{\alpha}$$

(c) $1 \times 1 = A\sqrt{2}$

$$\int_{-\infty}^{\infty} e^{-at^2} dt = 1$$

$$A = \frac{1}{\sqrt{2}}$$

(d) $\pi \times \pi = 2A\pi$

$$\int_{-\infty}^{\infty} \frac{1}{1+t^2} dt = \pi$$

$$A = \frac{\pi}{2}$$

10.

Sol: (i) $T = 4$

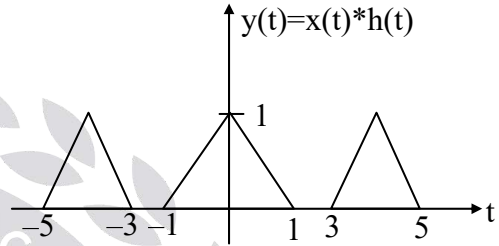
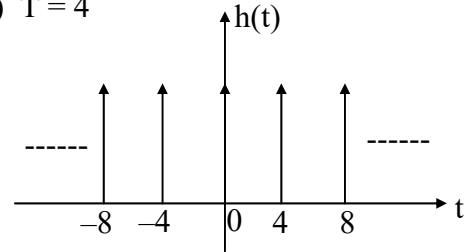

(ii) $T = 2$

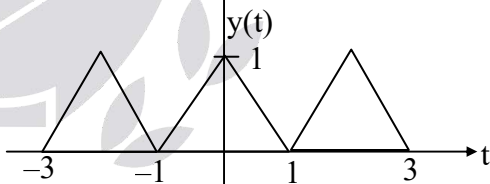
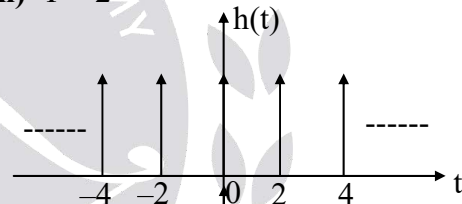

11.

Sol:

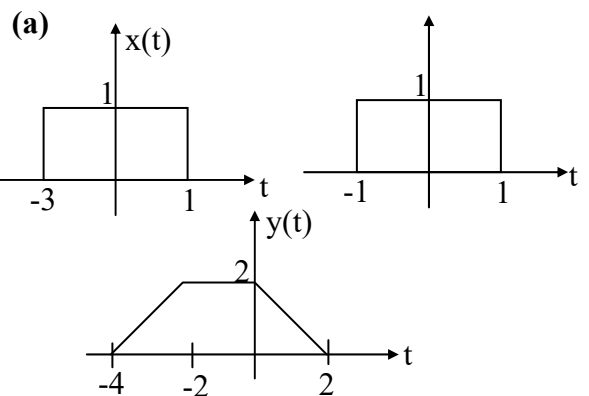

(b) Ans: (c)

$$tu(t) * u(t-1) \leftrightarrow \frac{1}{s^2} \frac{e^{-s}}{s}$$

$$= \frac{e^{-s}}{s^3} \leftrightarrow \frac{1}{2} (t-1)^2 u(t-1)$$

(c)

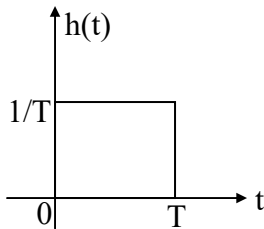

$$h(t) = \frac{1}{T} [u(t) - u(t-T)]$$

$$x(t) = u(t)$$

$$y(t) = x(t) * h(t) = \frac{1}{T} [r(t) - r(t-T)]$$

12. Ans: (a)

Sol: To get three discontinuities in $y(t)$ both rectangular pulse must be same width. To get equal width $h(t) = x(t)$. It is possible only
 $\alpha = 1$

13. Ans: (a)

Sol:

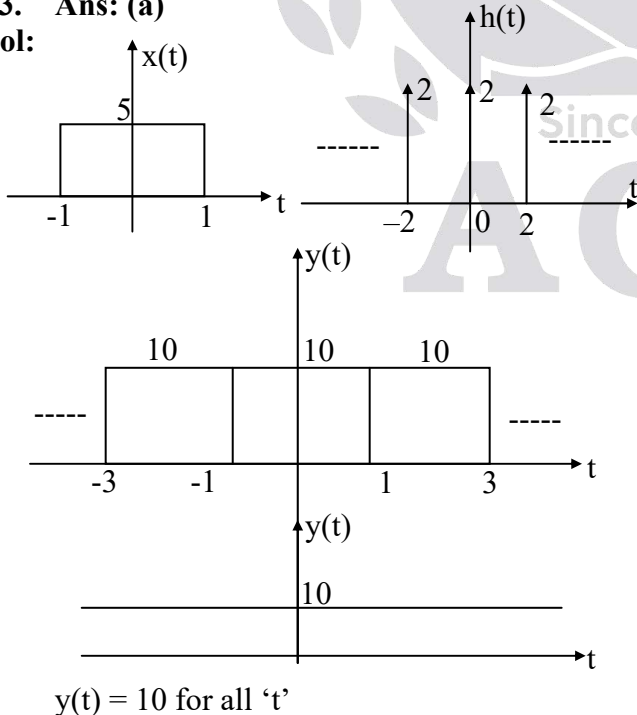

14. Ans: (d)

Sol: $x(t) * h(-t) = \int_{-\infty}^{\infty} x(\tau) h(-(t-\tau)) d\tau$

$$= \int_{-\infty}^{\infty} x(\tau) h(\tau-t) d\tau$$

15.

Sol: $y(n) = \dots + x(-2)g(n+4) + x(-1)g(n+2) + x(0)g(n) + x(1)g(n-2) + x(2)g(n-4) + \dots$

$$x(n) = \delta(n-2) = \begin{cases} 1 & n = 2 \\ 0 & \text{otherwise} \end{cases}$$

$$y(n) = g(n-4)$$

16.

Sol: $y(n) = x(n) * h(n)$

$$= 2(0.5)^n u(n) + (0.5)^{n-3} u(n-3)$$

$$y(1) = 1, y(4) = 5/8$$

17. Ans: (a)

Sol: $y(n) = [a, b, c, d, a, b, c, d, \dots, N \text{ times}]$

$y(n)$ is a periodic function with periodic '4'.

So $h(n)$ must be $h(n) = \sum_{i=0}^{N-1} \delta(n-4i)$

18. Ans: 31

Sol: $x(n) = \{1, 2, 1\}$

$$h(n) = \{1, x, y\}$$

$$y(n) = x(n) * h(n)$$

	1	x	y
1	1	x	y
2	2	2x	2y
1	1	x	y

$$y(n) = \{1, 2+x, 2x+y+1, x+2y, y\}$$

$$y(1) = 3 = 2+x \Rightarrow x = 1$$

$$y(2) = 4 = 2x+y+1 \Rightarrow y = 1$$

$$y(n) = \{1, 3, 4, 3, 1\}$$

$$10 y(3) + y(4) = 10 \times 3 + 1 = 31$$

19. **Ans: (d)**

$$\text{Sol: } \sum_{n=-\infty}^{\infty} h(n) = \sum_{n=0}^{\infty} a^n + \sum_{n=-\infty}^{-1} b^n < \infty$$

only when $|a| < 1, |b| > 1$

20. **Ans: (b)**

$$\text{Sol: } \int_{-\infty}^{\infty} |h(t)| dt = \int_0^{\infty} e^{\alpha t} dt + \int_{-\infty}^0 e^{\beta t} dt < \infty \quad \text{only when}$$

$$\alpha < 0, \beta > 0$$

21.

$$\text{Sol: (a) } h(n) = \alpha^n u(n) + \beta \alpha^{n-1} u(n-1)$$

$$\text{(b) } h(n) = 0 \quad n < 0 \text{ causal}$$

System stable for any value of 'β'

except $\beta \neq \infty$ and $|\alpha| < 1$, except $\alpha = 0$

22.

$$\text{Sol: (a) } \left(\frac{1}{5}\right)^n u(n) - A \left(\frac{1}{5}\right)^{n-1} u(n-1) = \delta(n)$$

When $n=1, A = 1/5$

$$\text{(b) } H(z) = \frac{1}{1 - \frac{1}{5}z^{-1}}$$

$$H_{\text{inv}}(z) = 1 - \frac{1}{5}z^{-1}$$

$$g(n) = \delta(n) - \frac{1}{5}\delta(n-1)$$

23.

$$\text{Sol: } h_1(n) = \delta(n) - \frac{1}{2}\delta(n-1)$$

$$h_1(n) * h_2(n) = \left(\frac{1}{2}\right)^n u(n) - \frac{1}{2} \left(\frac{1}{2}\right)^{n-1} u(n-1)$$

$$= \left(\frac{1}{2}\right)^n \delta(n) = \delta(n)$$

24.

Sol: 1. The convolution of one causal, one-non causal system is may be causal or non-causal. So, given statement is False.

2. $h(t) = e^{2t}u(t-1)$ is causal, un stable
So, given statement is false.

3. $h(t) = \sin \omega_0 t, \int_{-\infty}^{\infty} |h(t)| dt = \int_{-\infty}^{\infty} |\sin \omega_0 t| dt = \infty$
unstable. So, given statement is true

4. $y(t) = x(t-2) \rightarrow$ causal

$x(t) = y(t+2) \rightarrow$ non causal.

So, given statement is false

25. **Ans: (a)**

$$\text{Sol: } s(t) = u(t) - e^{-\alpha t}u(t)$$

$$h(t) = \frac{ds(t)}{dt} = \delta(t) - [e^{-\alpha t}\delta(t) - \alpha e^{-\alpha t}u(t)]$$

$$= \alpha e^{-\alpha t}u(t)$$

26.

$$\text{Sol: } s(n) = \sum_{k=-\infty}^n h(k) = \sum_{k=-\infty}^n \left(\frac{1}{2}\right)^k u(k)$$

$$= \sum_{k=0}^n \left(\frac{1}{2}\right)^k \quad n \geq 0$$

$$= 0 \quad n < 0$$

$$s(n) = 2 \left[1 - \left(\frac{1}{2}\right)^{n+1} \right] u(n)$$

27.

$$\text{Sol: } x(n) = u(n), y(n) = \delta(n)$$

$$u(n) - u(n-1) = \delta(n)$$

$$y(n) = x(n) - x(n-1)$$

$$\begin{aligned}x(n) &= nu(n) \\y(n) &= nu(n) - nu(n-1) + u(n-1) \\&= n\delta(n) + n(n-1) \\&= u(n-1)\end{aligned}$$

28.

Sol: $h_c(t) = h_1(t) * h_2(t)$

$$\begin{aligned}\int_{-\infty}^t h_c(\tau) d\tau &= \int_{-\infty}^t h_1(\tau) d\tau * h_2(\tau) \\&= h_1(\tau) * \int_{-\infty}^t h_2(\tau) d\tau\end{aligned}$$

$s_c(t) = s'_1(t) * s_2(t)$

$= s_1(t) * s'_2(t)$

$s_c(t) \neq s_1(t) * s_2(t)$

29.

- Sol:**
- (a) True
-
- (b) False
-
- (c) True
-
- (d) True

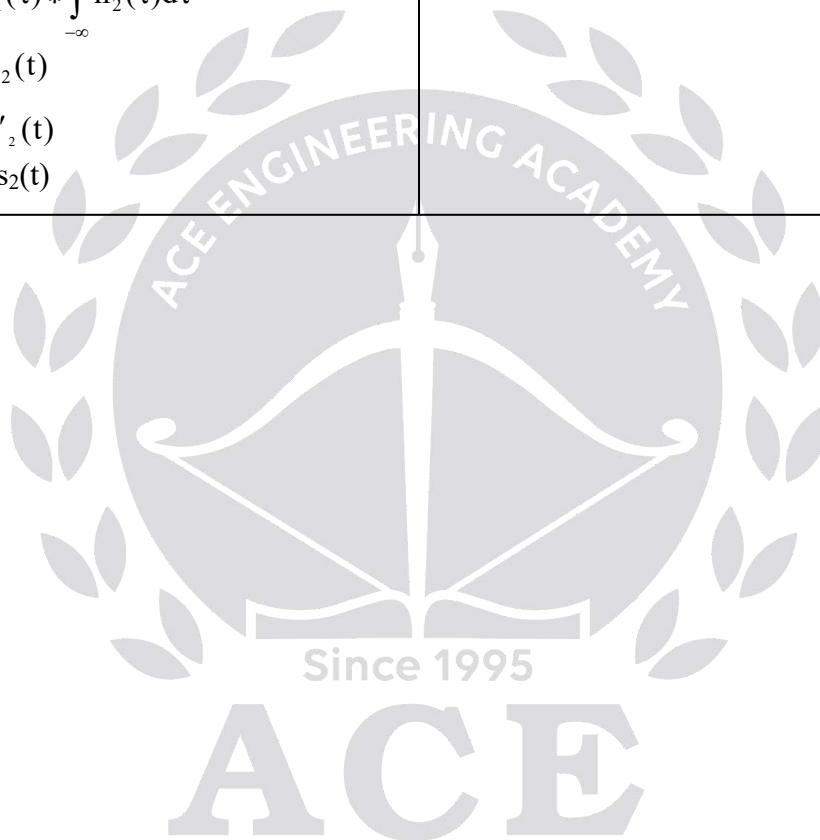

01. Ans: Zero

Sol: $T_1 = \frac{\pi}{2}, T_2 = \frac{\pi}{6}$

$$\frac{T_1}{T_2} = 3, T_0 = \text{LCM} \times T_1 = \frac{\pi}{2}$$

$$\omega_0 = 4$$

$$x(t) = 3\sin(\omega_0 t + 30^\circ) - 4\cos(3\omega_0 t - 60^\circ)$$

$$\text{second harmonic amplitude} = 0$$

02. Ans: (d)

Sol: (a) Given signal is periodic.

So, fourier series exists

(b) Given signal is periodic.

So, fourier series exists.

(c) Given signal is periodic.

So, fourier series exists.

(d) Given signal is non-periodic.

So, fourier series does not exist.

03.

Sol:

(P) Ans: (b)

Hidden symmetry a_0, b_n exists

(Q) Ans: (b)

Half wave symmetry a_n, b_n exists with odd harmonics

(R) Ans: (b)

Odd symmetry & HWS \rightarrow sine terms with odd 'n'

(S) Ans: (c)

Even and odd HWS $\rightarrow a_0$, cosine with odd 'n'

(T) Ans: (d)

$a_0 = 0$ (because average value = 0)

Even & HWS as cosine with odd 'n'

04. Ans: (b)

Sol: $f_1 = 5\text{Hz}, f_2 = 15\text{Hz}$

The signal lying with in the frequency band

$$10\text{Hz to } 20\text{ Hz is } 4\sin\left(30\pi t + \frac{\pi}{8}\right)$$

$$p = \frac{(4)^2}{2} = 8 \text{ Watts}$$

05. Ans: (b)

Sol: At $\omega_0 t = \pi/2$

$$x(t) = 1 - \frac{1}{3} + \frac{1}{5} - \frac{1}{7} + \dots$$

$$= \tan^{-1}(1) = \frac{\pi}{4}$$

06. Ans: (c)

Sol: $\omega = \frac{2\pi}{T}(2k), k = 1, 2, \dots$

The above frequency terms are absent.

The above frequency contains even harmonics and also gives that sin terms are absent. only cosine terms are present

Finally odd harmonics with cosine terms are present so, $x(t)$ it is a even and halfwave so,

$$x(t) = x(T-t) \text{ even}$$

$$x(t) = -x(t-T/2) \text{ halfwave}$$

07. Ans: (a)

Sol: $T_1 = 1, T_2 = 10\pi, T_3 = 8\pi, T_4 = \frac{20}{3}\pi$

$$T_0 = 40\pi$$

$$\omega_0 = \frac{2\pi}{T_0} = 0.05\text{rad/sec}$$

08. Ans: (a)

Sol: Average value = $\frac{1}{2} \frac{(2)(1) + (1)(1) + (1)(3)}{6} = \frac{5}{6}$

09. Ans: (a)

Sol: $a_0 = \frac{1}{2\pi} \int_0^{2\pi} f(t) dt$
 $a_0 = \text{Average value} = 0$

10. Ans: (d)

Sol: $T_0 = 4 \text{msec}$ $f_0 = \frac{1}{T_0} = 250 \text{Hz}$
 $5 f_0 = 1250 \text{ Hz}$

11. Ans: (b)

Sol: Odd + HWS → sine terms with odd harmonics

12. Ans: (a)

Sol: $(\text{RMS})^2 = \frac{1}{T} \int_0^T x^2(t) dt$

$$= \frac{1}{T} \left[\int_0^{T/2} \left(\frac{-12}{T} t \right)^2 dt + \int_{T/2}^T 36 dt \right]$$

$$= \frac{1}{T} \left[\frac{144}{T^2} \cdot \frac{t^3}{3} \Big|_0^{T/2} + 36t \Big|_{T/2}^T \right]$$

$$= \frac{1}{T} \left[\frac{144}{T^2} \left[\frac{T^3}{24} \right] + 36 \left(\frac{T}{2} \right) \right]$$

$$= \frac{1}{T} [6T + 18T]$$

$$= 24$$

$\text{RMS} = \sqrt{24} = 2\sqrt{6} \text{A}$

13. Ans: (c)

Sol: Average value = $\frac{1}{2\pi} \int_0^\pi 10 \sin t dt = \frac{10}{\pi}$

$$a_1 = \frac{2}{2\pi} \int_0^\pi 10 \sin t \cos t dt = 0$$

$$b_1 = \frac{2}{2\pi} \int_0^\pi 10 \sin t \sin t dt = 5$$

$$d_1 = \sqrt{a_1^2 + b_1^2} = 5$$

14. Ans: (d)

Sol: $\omega_0 = \pi$
 $x(t) = a_0 + \sum_{n=1}^{\infty} a_n \cos(n\pi t) + b_n \sin(n\pi t)$

$$x(t) = A \cos(\pi t)$$

$$A = a_1 = \int_0^2 x(t) \cos(n\omega_0) dt$$

$$= -\frac{4}{\pi^2}$$

15.

Sol: $a_0 = 5$
 $b_n = \int_0^1 10 \sin n\pi t dt = \frac{10[1 - (-1)^n]}{n\pi}$
 $a_n = 0$
 $x(t) = 5 + \frac{20}{\pi} \sin \pi t + \frac{20}{3\pi} \sin 3\pi t + \dots$

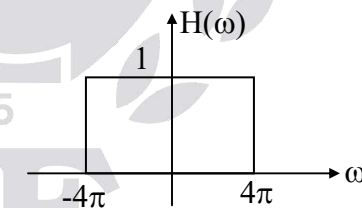

$$y(t) = 5 + \frac{20}{\pi} \sin \pi t + \frac{20}{3\pi} \sin 3\pi t$$

16.

Sol: $\omega_0 = \frac{\pi}{3}$
 $x(t) = 2 + \cos(2\omega_0 t) + 4 \sin(5\omega_0 t)$
 $x(t) = 2 + \frac{1}{2} e^{j2\omega_0 t} + \frac{1}{2} e^{-j2\omega_0 t} + \frac{4}{2j} e^{j5\omega_0 t} - \frac{4}{2j} e^{-j5\omega_0 t}$
 $c_0 = 2, c_2 = 1/2, c_{-2} = \frac{1}{2}, c_5 = \frac{4}{2j}, c_{-5} = \frac{-4}{2j}$

17.

$$\text{Sol: } c_n = \int_0^1 t e^{-jn\omega_0 t} dt = \int_0^1 t e^{-jn2\pi t} dt = \frac{j}{2n\pi}$$

$$c_0 = 1/2$$

$$a_n = c_n + c_{-n} = 0$$

$$b_n = j(c_n - c_{-n}) = \frac{-1}{n\pi}$$

18.

$$\text{Sol: (i) } y(t) \Rightarrow d_n = e^{-jn\omega_0} c_n = e^{-jn\pi} c_n = c_n (-1)^n$$

$$\text{(ii) } f(t) = x(t) - y(t)$$

$$d_n = c_n - (-1)^n c_n = c_n [1 - (-1)^n]$$

$$\text{(iii) } g(t) = x(t) + y(t)$$

$$d_n = c_n + (-1)^n c_n = c_n [1 + (-1)^n]$$

19. Ans: (b)

$$\text{Sol: } d_n = e^{-jn\omega_0 t_0} c_n + e^{jn\omega_0 t_0} c_n = 2 \cos(n\omega_0 t_0) c_n$$

$$\text{Assume } t_0 = \frac{T}{4}$$

$$d_n = 2c_n \cos\left(\frac{n\pi}{2}\right)$$

$$d_n = 0 \text{ for odd harmonics}$$

20.

$$\text{Sol: } y(t) = \frac{dx(t)}{dt}$$

$$d_n = jn\omega_0 c_n$$

$$c_n = \frac{d_n}{jn\omega_0}$$

$$d_n = \frac{1}{T} \int_{-T/2}^{T/2} (\delta(t+d/2) - \delta(t-d/2)) e^{-jn\omega_0 t} dt$$

$$= \frac{2j}{T} \sin\left(\frac{n\omega_0 d}{2}\right)$$

$$C_0 = \frac{d}{T}$$

21.

$$\text{Sol: } a_K = \frac{1}{T} \int_0^T x(t) e^{-jk\omega_0 t} dt$$

$$= \frac{1}{3} \left[\int_0^1 e^{-jk\frac{2\pi}{3}t} dt + \int_1^2 -e^{-jk\frac{2\pi}{3}t} dt \right]$$

$$= \frac{1}{3} \left[\frac{e^{-jk\frac{2\pi}{3}t}}{-jk\frac{2\pi}{3}} \Big|_0^1 - \frac{e^{-jk\frac{2\pi}{3}t}}{-jk\frac{2\pi}{3}} \Big|_1^2 \right]$$

$$= \frac{1}{-jk2\pi} \left[\left(e^{-jk\frac{2\pi}{3}} - 1 \right) - \left(e^{-jk\frac{4\pi}{3}} - e^{-jk\frac{2\pi}{3}} \right) \right]$$

$$a_k = \frac{1}{jk2\pi} \left[1 - 2e^{-jk\frac{2\pi}{3}} + e^{-jk\frac{4\pi}{3}} \right]$$

22. Ans: (c)

Sol: W_1 is a periodic square waveform with period T and it is having odd symmetry and also odd harmonic symmetry (or Half-wave symmetry).

W_2 is a periodic triangular waveform with period T and it is having odd symmetry and also odd harmonic symmetry (or Half-wave symmetry).

\therefore Only odd harmonics: nf_0 , $n = 1, 3, 5$ etc of sine terms are present in wave forms W_1 and W_2 in their Fourier series expansion.

Note that waveform, W_2 can be obtained by integrating the waveform, W_1 .

If c_n is the exponential FS coefficient of the n^{th} harmonic component, $c_n e^{jn\omega_0 t}$

$$|c_n| \propto \left| \frac{1}{n} \right| = |n^{-1}| \text{ for wave form } W_1$$

$$|c_n| \propto \left| \frac{1}{n^2} \right| = |n^{-2}| \text{ for wave form } W_2$$

23.
Sol:
(a) Polar form of TFS

$$= d_0 + \sum_{n=1}^{\infty} d_n \cos(n\omega_0 t + \phi_n)$$

$$d_n = 2 |c_n|$$

$$d_0 = 2, d_1 = 4, d_2 = 4, d_3 = 4$$

$$\begin{aligned} \text{polar form} &= 2 + 4\cos(\omega_0 t + 30^\circ) \\ &\quad + 4\cos(2\omega_0 t + 60^\circ) \\ &\quad + 4\cos(3\omega_0 t + 90^\circ) \end{aligned}$$

(b) $x(t) \leftrightarrow c_n$

$$x(at) \leftrightarrow c_n, \omega_0 = a\omega_0$$

$$x(t) \leftrightarrow c_n$$

$$x(t - t_0) \leftrightarrow e^{-jn\omega_0 t_0} c_n$$

$$\frac{dx(t)}{dt} \leftrightarrow (jn\omega_0) c_n$$

24.
Sol:

$$\text{(a)} C_n = \frac{1}{T_0} \int_0^{T_0} x(t) e^{-jn\omega_0 t} dt$$

$$C_n = \frac{1}{2} \int_0^1 1 \cdot e^{-jn\pi t} dt$$

$$C_n = \frac{1 - (-1)^n}{2jn\pi}$$

$$C_0 = \frac{1}{2} \int_0^1 dt = \frac{1}{2}$$

$$C_{-1} = \frac{j}{\pi}, C_1 = \frac{-j}{\pi}, C_{-2} = 0, C_2 = 0$$

Power upto second harmonics is

$$P = \sum_{n=-2}^2 |C_n|^2 = \frac{1}{\pi^2} + \frac{1}{4} + \frac{1}{\pi^2} = 0.453 \text{ W}$$

$$\begin{aligned} \text{(b)} c_k &= \frac{1}{8} \left[\int_0^4 e^{-jk\frac{\pi}{4}t} dt + \int_4^8 -e^{-jk\frac{\pi}{4}t} dt \right] \\ &= \frac{1}{8} \left[\frac{e^{-jk\frac{\pi}{4}t}}{-jk\frac{\pi}{4}} \Big|_0^4 - \frac{e^{-jk\frac{\pi}{4}t}}{-jk\frac{\pi}{4}} \Big|_4^8 \right] \end{aligned}$$

$$= \frac{1}{-jk2\pi} \left[e^{-jk\pi} - 1 - \left(e^{-jk2\pi} - e^{-jk\pi} \right) \right]$$

$$= \frac{-1}{jk2\pi} \left[(-1)^k - 1 - 1 + (-1)^k \right]$$

$$c_k = \frac{2}{jk2\pi} \left[1 - (-1)^k \right]$$

$$c_k = 0 \text{ for 'K' even (K=10)}$$

$$\text{Power} = 0$$

25.
Sol: (a) All periodic signals are power signals.

 For power signal $E = \infty$ [given is false]

 (b) $C_0 = j2$ (average value) [given is false]

$$\text{(c)} \frac{j}{T} \int_0^T x_I(t) dt = j2$$

$$\frac{1}{T} \int_0^T x_I(t) dt = 2 \text{ is possible only when}$$

 $x_I(t)$ is constant. So given is correct

$$\begin{aligned} \text{(d)} C_0 &= \frac{1}{T} \int_0^T x_R(t) dt + \frac{j}{T} \int_0^T x_I(t) dt \\ &= 0 + j2 \end{aligned}$$

$$\frac{1}{T} \int_0^T x_R(t) dt = 0 \text{ only when } x_R(t) \text{ is odd}$$

given is in correct

26.
Sol:

$$\text{(a)} \text{Power} = \frac{1}{T} \int_{-\infty}^{\infty} |x(t)|^2 dt = \sum_{n=-\infty}^{\infty} |C_n|^2$$

$$\begin{aligned} P &= \sum_{n=-4}^4 |C_n|^2 \\ &= (0.5)^2 + (1)^2 + (2)^2 + (4)^2 + (2)^2 + (1)^2 + (0.5)^2 \\ &= 26.5 \text{ Watts} \end{aligned}$$

$$\text{(b)} x(t) = \sum_{n=-\infty}^{\infty} C_n e^{jn\omega_0 t}$$

$$\begin{aligned} &= C_{-4} e^{-j4\omega_0 t} + C_{-3} e^{-j3\omega_0 t} e^{-\frac{j\pi}{2}} + C_{-2} e^{-j2\omega_0 t} e^{-\frac{j\pi}{4}} + C_{-1} e^{-j\omega_0 t} \\ &\quad + C_0 + C_1 e^{j\omega_0 t} + C_2 e^{j2\omega_0 t} e^{\frac{j\pi}{4}} + C_3 e^{j3\omega_0 t} e^{\frac{j\pi}{2}} + C_4 e^{j4\omega_0 t} \end{aligned}$$

$$\begin{aligned}
 &= 0.5e^{-j4\omega_0 t} + 1e^{-j3\omega_0 t - \frac{\pi}{2}} \\
 &\quad + 2e^{-j2\omega_0 t - \frac{\pi}{4}} + 0.5e^{j4\omega_0 t} + 1e^{j3\omega_0 t + \frac{\pi}{2}} + 2e^{j2\omega_0 t + \frac{\pi}{4}} + 4 \\
 &= (0.5)[e^{-j4\omega_0 t} + e^{j4\omega_0 t}] + 2\left[e^{-j2\omega_0 t - \frac{\pi}{4}} + e^{j2\omega_0 t + \frac{\pi}{4}}\right] \\
 &\quad \left[e^{-j3\omega_0 t - \frac{\pi}{2}} + e^{j3\omega_0 t + \frac{\pi}{2}}\right] + 4
 \end{aligned}$$

$$\begin{aligned}
 \Rightarrow x(t) &= \cos 4\omega_0 t + 4 \cos\left(2\omega_0 t + \frac{\pi}{4}\right) \\
 &\quad + 2 \cos\left(3\omega_0 t + \frac{\pi}{2}\right) + 4
 \end{aligned}$$

$$x(t) \neq x(-t)$$

$$x(-t) \neq -x(t)$$

So, neither even nor odd signal.

(c) $f_0 = 10 \text{ Hz}$

$$\omega_0 = 2\pi f_0 = 20 \pi \text{ rad}$$

$$\begin{aligned}
 x(t) &= \cos(80\pi t) + 4 \cos\left(40\pi t + \frac{\pi}{4}\right) \\
 &\quad + 2 \cos\left(60\pi t + \frac{\pi}{2}\right) + 4
 \end{aligned}$$

(d) Cut off frequency = 25 Hz
 $= 50 \pi \text{ rad}$

So output of the filter is

$$y(t) = 4 \cos\left(40\pi t + \frac{\pi}{4}\right) + 4$$

27.

Sol: A. Fourier transform of periodic impulse train is also periodic impulse train

$$A \rightarrow 2$$

B. For a full wave rectified wave form

$$c_n = \frac{2A}{\pi(1-4n^2)}, n \text{ is even}$$

$$B \rightarrow 1$$

$$C \rightarrow 3$$

D. Given signal satisfied half-wave symmetry so only harmonics are present

$$D \rightarrow 4$$

28. **Ans: (b)**

Sol: Frequency is constant. So, S_1 is LTI system, frequency is not constant. So, S_2 is not LTI system.

29. **Ans: (d)**

Sol: Fourier series expresses the given periodic waveform as a combination of d.c. component, sine and cosine waveforms of different harmonic frequencies as

$$\begin{aligned}
 f(t) &= a_0 + \sum_{n=1}^{\infty} a_n \cos(n\omega_0 t) + \sum_{n=1}^{\infty} b_n \sin(n\omega_0 t) \\
 &= A_0 + A_n \cos(n\omega_0 t + \phi_n)
 \end{aligned}$$

So, statement (1) is true.

A_n and ϕ_n (Amplitude and phase spectra) occur at discrete frequencies.

So, statement (2) is true.

Waveform symmetries (Even, odd, Half-wave) simplify the evaluation of FS coefficients.

So, statement (3) is true.

Statements 1, 2, 3 are correct.

30. **Ans: (d)**

Sol: For a real valued periodic function $f(t)$ of frequency f_0

$$C_n = C_{-n}^*$$

Statement (I) is False but Statement (II) is True because the discrete magnitude spectrum of real function $f(t)$ is even and phase spectrum is odd.

31. **Ans: (d)**

Sol: S_1, S_3 are not LTI.

Chapter

4

Fourier Transform

01.

Sol: $X(f) = \int_{-\infty}^{\infty} x(t)e^{-j2\pi ft} dt$

$x(t)$ units are volts and dt units are sec

So, Unit of $X(f)$ is volt-sec (or) volt/Hz

02.

Sol:

(a) $X(0) = \int_{-\infty}^{\infty} x(t)dt = \text{area}$
 $= (4 \times 2) - \left(\frac{1}{2} \times 1 \times 2\right) = 7$

(b) $2\pi x(0) = 2\pi \times 2 = 4\pi$

03.

Sol:

(i) $x(t) = e^{-at}u(t) + e^{at}u(-t)$

$$X(\omega) = \frac{1}{a + j\omega} + \frac{1}{a - j\omega} = \frac{2a}{a^2 + \omega^2}$$

(ii) $e^{-at}u(t) - e^{at}u(-t) \leftrightarrow \frac{-2j\omega}{a^2 + \omega^2}$

As $a \rightarrow 0$

$$u(t) - u(-t) \leftrightarrow \frac{2}{j\omega}$$

$$\text{sgn}(t) \leftrightarrow \frac{2}{j\omega}$$

04.

Sol: $G(\omega) = 1 + \frac{12}{\omega^2 + 9}$

Apply inverse Fourier Transform

$$g(t) = \delta(t) + 2e^{-3|t|}$$

05. **Ans: Zero**

Sol: $x(t) = \text{rect}(t/2), \quad X(\omega) = 2\text{sinc}(\omega)$

$$y(t) = x(t) + x(t/2), \quad Y(\omega) = X(\omega) + 2X(2\omega)$$

$$Y(\omega) = \frac{2 \sin \omega}{\omega} + \frac{4 \sin 2\omega}{\omega}$$

$$f = 1 \Rightarrow \omega = 2\pi, Y(2\pi) = 0$$

06. **Ans: (d)**

Sol: $Y(\omega) = 3X(2\omega)$

$$x(at) \leftrightarrow \frac{1}{|a|} X\left(\frac{\omega}{a}\right)$$

$$x\left(\frac{t}{2}\right) \leftrightarrow 2X(2\omega)$$

$$\frac{1}{2}x\left(\frac{t}{2}\right) \leftrightarrow X(2\omega)$$

$$y(t) = 3/2 x(t/2)$$

07.

Sol: i) $1 \leftrightarrow 2\pi\delta(\omega)$

ii) $\frac{1}{a + jt} \leftrightarrow 2\pi e^{a\omega} \cdot u(-\omega)$

iii) $\frac{2a}{a^2 + t^2} \leftrightarrow 2\pi e^{-a|\omega|}$

iv) $\frac{1}{\pi t} \leftrightarrow -j \text{sgn}(\omega)$

08.

Sol: $x_1(t) = \text{rect}\left(\frac{t}{1}\right) \quad X_1(f) = \text{Sinc}(f)$

$$x(t) = x\left(t - \frac{1}{2}\right) \quad X(f) = e^{-j\pi f} X(f)$$

$$\text{FT}[x(t) + x(-t)] = X(f) + X(-f)$$

$$= 2\cos(\pi f) \cdot \text{Sinc}(f)$$

09.

Sol: $u(t) \leftrightarrow \pi\delta(\omega) + \frac{1}{j\omega}$

$$\frac{1}{jt} + \pi\delta(t) \leftrightarrow 2\pi u(-\omega)$$

$$\frac{1}{2}\delta(t) - \frac{1}{j2\pi t} \leftrightarrow u(\omega)$$

10.

Sol:

i) $x(t) = e^{-3(t-1)}u(t-1)e^{-3}$

$$X(\omega) = e^{-j\omega}e^{-3} \frac{1}{3 + j\omega}$$

ii) $\pi\left(\frac{t}{2}\right) \leftrightarrow 2\text{Sa}(\omega)$

$$\pi\left(\frac{t-1}{2}\right) \leftrightarrow 2e^{-j\omega}\text{Sa}(\omega)$$

iii) $e^{-2|t|} \leftrightarrow \frac{4}{4 + \omega^2}$

$$e^{-2|t-2|} \leftrightarrow \frac{4e^{-2j\omega}}{4 + \omega^2}$$

11.

Sol:

(a) $f_1(t) = f(t-1/2) + f(-t-1/2)$

$$F_1(\omega) = e^{-j\omega/2}F(\omega) + e^{j\omega/2}F(-\omega)$$

(b) $f_2(t) = \frac{3}{2}f\left(\frac{t}{2}-1\right)$

$$F_2(\omega) = 3e^{-2j\omega}F(2\omega)$$

12.

Sol: $Y(\omega) = \frac{\cos\left(\frac{\omega}{2}\right)e^{-j\frac{\omega}{2}}}{1 + j\omega}$

$$= \left[\frac{e^{j\frac{\omega}{2}} + e^{-j\frac{\omega}{2}}}{2} \right] e^{-j\frac{\omega}{2}} X(\omega)$$

$$Y(\omega) = \left[\frac{1 + e^{-j\omega}}{2} \right] X(\omega)$$

Assume, $X(\omega) = \frac{1}{1 + j\omega}$
 $x(t) = e^{-t}u(t)$

By applying Inverse Fourier Transform

$$y(t) = \frac{1}{2}[x(t) + x(t-1)]$$

$$y(t) = \frac{1}{2}[e^{-t}u(t) + e^{-(t-1)}u(t-1)]$$

13.

Sol:

i) $\cos\omega_0 t = \frac{1}{2}[e^{j\omega_0 t} + e^{-j\omega_0 t}] \leftrightarrow \pi[\delta(\omega + \omega_0) + \delta(\omega - \omega_0)]$

ii) $\sin\omega_0 t \leftrightarrow \frac{\pi}{j}[\delta(\omega - \omega_0) - \delta(\omega + \omega_0)]$

iii) $e^{-at} \sin\omega_c t u(t) \leftrightarrow \frac{1}{2j} \left[\frac{1}{a + j(\omega - \omega_c)} - \frac{1}{a + j(\omega + \omega_c)} \right]$

iv) $\text{Arect}\left(\frac{t}{T}\right) \cos\omega_0 t = \frac{AT}{2} \left[\text{Sa}\left[\frac{\omega + \omega_0}{2}\right]_T + \text{Sa}\left[\frac{\omega - \omega_0}{2}\right]_T \right]$

14.

Sol: $\text{Sinc}(t) \leftrightarrow \text{rect}(f)$

$$\text{Sinc}(t) \cos(10\pi t) \leftrightarrow \frac{1}{2} [\text{rect}(f-5) + \text{rect}(f+5)]$$

15.

Sol: (i) $e^{-j3t}x(t) \leftrightarrow X(\omega + 3)$

(Frequency sifting property)

$$e^{-j\frac{3}{4}t}x(t/4) \leftrightarrow 4X(4\omega + 3)$$

(Time scaling property)

$$\frac{1}{4}e^{-j\frac{3}{4}t}x(t/4) \leftrightarrow X(4\omega + 3)$$

(ii) **Ans: (a)**

$$X(\omega) = 2\pi\delta(\omega) + \pi[\delta(\omega - 4\pi) + \delta(\omega + 4\pi)]$$

$$x(t) = 1 + \cos(4\pi t)$$

16. Sol:

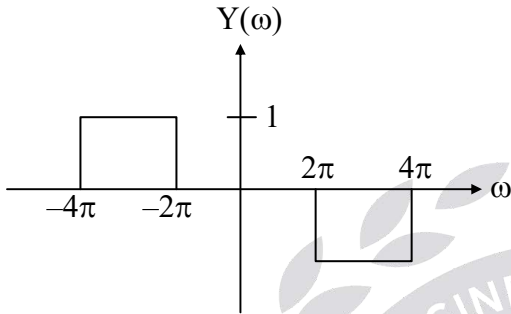

$$Y(\omega) = X(\omega + 3\pi) - X(\omega - 3\pi)$$

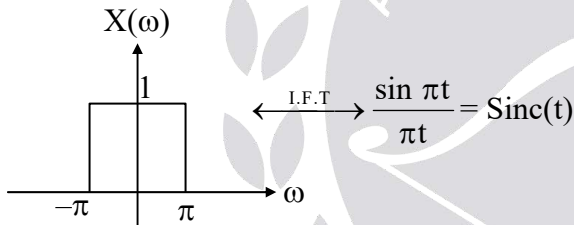

By applying Inverse Fourier Transform

$$\begin{aligned} y(t) &= x(t) e^{j(-3\pi)t} - x(t) e^{j3\pi t} \\ &= -\left[\frac{e^{j3\pi t} - e^{-j3\pi t}}{2j} \right] (2j)x(t) \\ &= -2j \text{Sinc}(t) \sin(3\pi t) \end{aligned}$$

17. Ans: (b)

Sol:

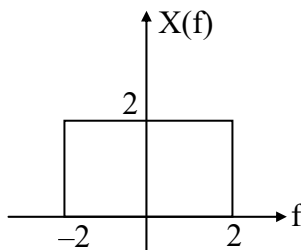

$$x(t) \cos 2\pi t \leftrightarrow \frac{1}{2} [X(f-1) + X(f+1)]$$

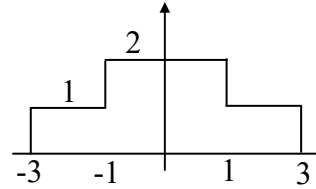

18. Ans: (d)

Sol: Output of multiplier

$$= \frac{1}{2} x(t) \cos(2\omega_c t + \theta) + \frac{1}{2} x(t) \cos \theta$$

$$\begin{aligned} \text{Output of the filter is} &= \frac{1}{2} x(t) \cos \theta \times 2 \\ &= x(t) \cos \theta \end{aligned}$$

19. Ans: (c)

Sol: $y(t) = \frac{dx(t)}{dt}$

$$Y(\omega) = j\omega X(\omega)$$

It $x(t)$ is even function, then $y(t)$ is odd function.

It $x(t)$ is triangular function $X(\omega)$ is Sinc^2 function, it is real.

$y(t)$ is odd function, $Y(\omega)$ is imaginary.

20. Ans: $= \frac{-1}{2\sqrt{\pi}}$

Sol: $x(t) = \frac{1}{2\pi} \left[\int_{-\infty}^{\infty} X(\omega) e^{j\omega t} d\omega \right]$

$$\frac{dx(t)}{dt} = \frac{1}{2\pi} \int_{-\infty}^{\infty} j\omega X(\omega) e^{j\omega t} d\omega$$

$$\left. \frac{dx(t)}{dt} \right|_{t=0} = \frac{1}{2\pi} \int_{-\infty}^{\infty} j\omega X(\omega) d\omega$$

$$= \frac{1}{2\pi} \left[\int_{-1}^0 j\omega (-j\sqrt{\pi}) d\omega + \int_0^1 j\omega (j\sqrt{\pi}) d\omega \right]$$

$$= \frac{-1}{2\sqrt{\pi}}$$

21.

Sol: $te^{-a|t|} \leftrightarrow j \frac{d}{d\omega} \left[\frac{2a}{a^2 + \omega^2} \right] = \frac{-4ja\omega}{(a^2 + \omega^2)^2}$

$$te^{-|t|} \leftrightarrow \frac{-4j\omega}{(\omega^2 + 1)^2}$$

Apply duality property

$$\frac{4t}{(t^2 + 1)^2} \leftrightarrow -2\pi j\omega e^{-|\omega|}$$

22.

Sol:

(i) $X_1(\omega) = e^{-2j\omega} X(-\omega) + e^{2j\omega} X(-\omega)$

(ii) $X_2(\omega) = \frac{1}{3} e^{-2j\omega} X\left(\frac{\omega}{3}\right)$

(iii) $X_3(\omega) = (j\omega)^2 e^{-3j\omega} X(\omega)$

(iv) $X_4(\omega) = j \frac{d}{d\omega} [j\omega X(\omega)]$

23.

Sol: $x(t) = \text{rect}(t/2)$

$$X(\omega) = \frac{2 \sin \omega}{\omega}$$

(a) $y_1(t) = x(t-1) \Rightarrow Y_1(\omega) = e^{-j\omega} X(\omega)$

(b) $\Rightarrow y_2(t) = x(t) * x(t)$

$$Y_2(\omega) = X(\omega) X(\omega) = \frac{2 \sin \omega}{\omega} \frac{2 \sin \omega}{\omega}$$

$$Y_2(\omega) = 4 \frac{\sin^2 \omega}{\omega^2}$$

(c) $y_3(t) = tx(t) \quad Y_3(\omega) = j \frac{d}{d\omega} [X(\omega)]$

(d) $y_4(t) = x(t) \sin \pi t \leftrightarrow \frac{1}{2j} [X(\omega - \pi) - X(\omega + \pi)]$

(e) $y_5(t) = \frac{dx(t)}{dt} \leftrightarrow j\omega X(\omega)$

(f) $y_6(t) = (t+1)x(t) + 2u(t-1)$

(g) $y_7(t) = y_1\left(\frac{t}{2}\right) \leftrightarrow 2Y_1(2\omega)$

(h) $y_8(t) = y_2(2(t+1)) - y_2(2(t-1))$

$$Y_8(\omega) = \frac{1}{2} Y_2\left(\frac{\omega}{2}\right) e^{-j\omega(-1)} - \frac{1}{2} Y_2\left(\frac{\omega}{2}\right) e^{-j\omega(1)}$$

$$= \frac{1}{2} Y_2\left(\frac{\omega}{2}\right) e^{j\omega} - \frac{1}{2} Y_2\left(\frac{\omega}{2}\right) e^{-j\omega}$$

$$= \frac{1}{2} Y_2\left(\frac{\omega}{2}\right) [e^{j\omega} - e^{-j\omega}]$$

(i) $y_9(t) = x\left(\frac{t}{2}\right) - \frac{1}{2} y_2(t)$

$$Y_9(\omega) = 2X(2\omega) - \frac{1}{2} Y_2(\omega)$$

(j) $z(t) = \frac{1}{2} y_2(2t)$

$$y_{10}(t) = z(t+1) + z(t) + z(t-1)$$

$$Y_{10}(\omega) = (1 + 2\cos \omega) Z(\omega)$$

24. **Ans: $y(t) = \cos 2t$**

Sol: $h(t) = \frac{\sin 4t}{\pi t} \quad H(\omega) = \text{rect}\left(\frac{\omega}{8}\right)$

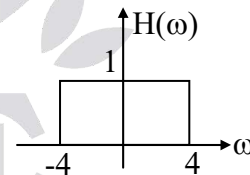

$$y(t) = \cos 2t$$

25.

Sol: $X(\omega) = \text{rect}\left(\frac{\omega}{2\omega_1}\right) + \text{rect}\left(\frac{\omega}{2\omega_2}\right)$

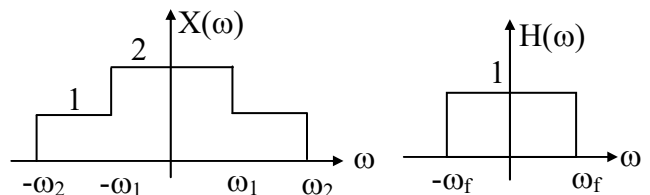

(a) $0 < \omega_f < \omega_1$ $Y(\omega) = X(\omega) \cdot H(\omega)$

$$y(t) = \frac{2 \sin \omega_f t}{\pi t}$$

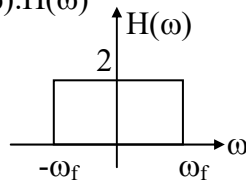

(b) $\omega_1 < \omega_f < \omega_2$

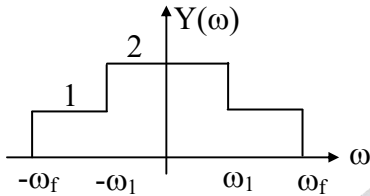

$$y(t) = \frac{\sin \omega_1 t}{\pi t} + \frac{\sin \omega_f t}{\pi t}$$

(c) $\omega_f > \omega_2$ $y(t) = \frac{\sin \omega_1 t}{\pi t} + \frac{\sin \omega_2 t}{\pi t}$

26.
Sol:

(a) $X(\omega) = \delta(\omega) + \delta(\omega-5) + \delta(\omega-\pi)$

$$x(t) = 1 + e^{-j5t} + e^{-j\pi t}$$

$$e^{-j\pi t} \Rightarrow T_1 = \frac{2\pi}{\pi} = 2$$

$$e^{-j5t} \Rightarrow T_2 = \frac{2\pi}{5} = \frac{2\pi}{5}$$

$$\frac{T_1}{T_2} = \frac{5}{\pi} \text{ is irrational}$$

So, non-periodic

(b) $h(t) = u(t) - u(t-2)$

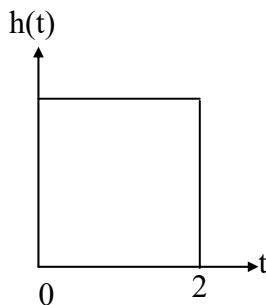

$$\Rightarrow h(t) = \text{rect}\left(\frac{t}{2} - 0.5\right)$$

$$\text{rect}(t) \leftrightarrow \frac{\sin \frac{\omega}{2}}{\frac{\omega}{2}}$$

$$\text{rect}\left(\frac{t}{2} - 0.5\right) \leftrightarrow 2e^{-j\omega} \frac{\sin \omega}{\omega}$$

$$\Rightarrow H(\omega) = 2e^{-j\omega} \frac{\sin \omega}{\omega}$$

$$x(t) * h(t) \leftrightarrow H(\omega) X(\omega)$$

$$X(\omega)H(\omega) = [\delta(\omega) + \delta(\omega-5) + \delta(\omega-\pi)] \left[2e^{-j\omega} \frac{\sin \omega}{\omega} \right]$$

$$= \delta(\omega) \lim_{x \rightarrow 0} 2e^{-j\omega} \frac{\sin \omega}{\omega} + \delta(\omega-5) 2e^{-j5} \frac{\sin 5}{5}$$

$$+ \delta(\omega) 2e^{-j\pi} \frac{\sin \pi}{\pi}$$

$$= 2\delta(\omega) + 2e^{-j5} \frac{\sin 5}{5} \delta(\omega-5) \left[\lim_{x \rightarrow \pi} \frac{\sin x}{x} = 0 \right]$$

$$X(\omega)H(\omega) = 2\delta(\omega) + 2e^{-j5} \frac{\sin 5}{5} \delta(\omega-5)$$

$$\Rightarrow x(t) * h(t) = 2 + 2e^{-j5} \frac{\sin 5}{5} e^{-j5t}$$

\Rightarrow Periodic

(c) In above problem, convolution of two non periodic signals can be a periodic signal

27.

Sol:

(a) $y_1(t) = \text{rect}(t) * \cos \pi t$

$$\text{rect}(t) \leftrightarrow \frac{2}{\omega} \sin \frac{\omega}{2} \left[\because Y(\omega) = \int_{-\infty}^{\infty} y(t) e^{-j\omega t} dt \right]$$

$$\text{rect}(t) \leftrightarrow \frac{\sin\left(\frac{\omega}{2}\right)}{\left(\frac{\omega}{2}\right)}$$

$$\text{rect}(t) \leftrightarrow \frac{\sin\left(\pi \cdot \frac{\omega}{2\pi}\right)}{\pi \frac{\omega}{2\pi}}$$

$$\text{rect}(t) \leftrightarrow \text{sinc}\left(\frac{\omega}{2\pi}\right)$$

$$\cos \pi \leftrightarrow \pi [\delta(\omega - \pi) + \delta(\omega + \pi)]$$

$$Y_1(\omega) = \text{sinc}\left(\frac{\omega}{2\pi}\right) \times \pi [\delta(\omega - \pi) + \delta(\omega + \pi)]$$

$$Y_1(\omega) = \frac{2}{\omega} \sin \frac{\omega}{2} \times \pi [\delta(\omega - \pi) + \delta(\omega + \pi)]$$

$$= \frac{2}{\omega} \sin \frac{\omega}{2} \times \pi \delta(\omega - \pi) + \frac{2}{\omega} \sin \frac{\omega}{2} \times \pi \delta(\omega + \pi)$$

$$= \frac{2}{\pi} \sin \frac{\pi}{2} \pi \delta(\omega - \pi) + \frac{2}{-\pi} \sin\left(\frac{-\pi}{2}\right) \pi \delta(\omega + \pi)$$

$$= 2 \delta(\omega - \pi) + 2 \delta(\omega + \pi)$$

$$Y_1(\omega) = \frac{2}{\pi} \pi [\delta(\omega - \pi) + \delta(\omega + \pi)]$$

Taking inverse fourier transform

$$\therefore y_1(t) = \frac{2}{\pi} \cos \pi t$$

(b) $y_2(t) = \text{rect}(t) * \cos 2\pi t$

Similar to above

$$Y_2(\omega) = \frac{2}{\omega} \sin \frac{\omega}{2} \times \pi [\delta(\omega - 2\pi) + \delta(\omega + 2\pi)]$$

$$= \frac{2}{\omega} \sin\left(\frac{\omega}{2}\right) \pi \delta(\omega - 2\pi) + \frac{2}{\omega} \sin\left(\frac{\omega}{2}\right) \pi \delta(\omega + 2\pi)$$

$$= \frac{2}{2\pi} \sin\left(\frac{2\pi}{2}\right) \pi \delta(\omega - 2\pi) + \frac{2}{-2\pi} \sin\left(\frac{-2\pi}{2}\right) \pi \delta(\omega + 2\pi) = 0$$

$$\therefore y_2(t) = 0$$

(c) $y_3(t) = \text{sinc}(t) * \text{sinc}\left(\frac{t}{2}\right)$

$$\text{rect}(t) \leftrightarrow \text{sinc}\left(\frac{\omega}{2\pi}\right)$$

$$\text{sinc}\left(\frac{t}{2\pi}\right) \leftrightarrow 2\pi \text{rect}(-\omega)$$

$$\text{sinc}\left(\frac{t}{2\pi}\right) \leftrightarrow 2\pi \text{rect}(\omega)$$

$$\text{sinc}(t) \leftrightarrow \text{rect}\left(\frac{\omega}{2\pi}\right)$$

$$\text{sinc}\left(\frac{t}{2}\right) \leftrightarrow 2 \text{rect}\left(\frac{\omega}{\pi}\right)$$

$$\therefore Y_3(\omega) = \text{rect}\left(\frac{\omega}{2\pi}\right) 2 \text{rect}\left(\frac{\omega}{\pi}\right)$$

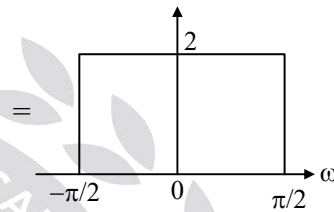
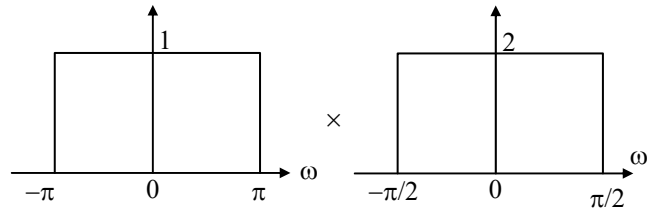

$$Y_3(\omega) = 2 \text{rect}\left(\frac{\omega}{\pi}\right)$$

$$Y_3(\omega) \leftrightarrow 2 \text{rect}\left(\frac{\omega}{\pi}\right)$$

Taking inverse fourier transform

$$y_3(t) = \text{sinc}\left(\frac{t}{2}\right)$$

(d) $\text{sinc}(t) \leftrightarrow \text{rect}\left(\frac{\omega}{2\pi}\right)$

$$e^{j3\pi t} \text{sinc}(t) \leftrightarrow \text{rect}\left(\frac{\omega - 3\pi}{2\pi}\right)$$

$$\text{sinc}(t) * e^{j3\pi t} \text{sinc}(t) \leftrightarrow \text{rect}\left(\frac{\omega}{2\pi}\right) \times \text{rect}\left(\frac{\omega - 3\pi}{2\pi}\right)$$

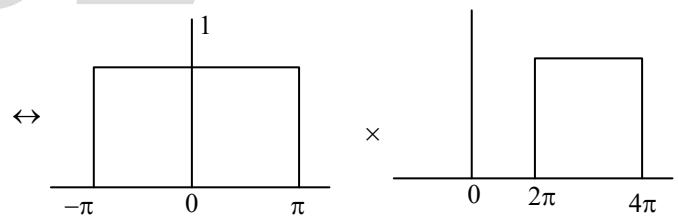

$$\leftrightarrow 0$$

$$\therefore Y_4(\omega) = 0$$

$$\Rightarrow y_4(t) = 0$$

28.

Sol:

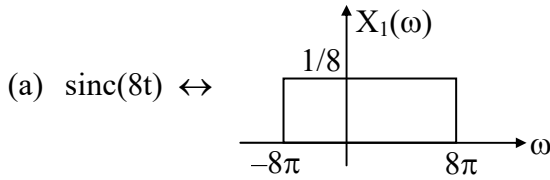

$$H(\omega) = 8e^{-j\omega} X_1(\omega) = e^{-j\omega} \quad -8\pi < \omega < 8\pi$$

$$= 0 \quad \text{otherwise}$$

$$Y(\omega) = \pi e^{-j\omega} [\delta(\omega + \pi) + \delta(\omega - \pi)]$$

$$y(t) = \cos\pi(t - 1)$$

(b) **Ans: (d)**

$$G(f) = e^{-\pi f^2} \quad H(f) = e^{-\pi f^2}$$

$$Y(f) = G(f)H(f) = e^{-2\pi f^2}$$

(c) $y_1(t) = (\text{Sinc}(2t))^2$

$$= \frac{\sin 2\pi t}{2\pi t} \cdot \frac{\sin 2\pi t}{2\pi t}$$

$$= \frac{1}{4} \frac{\sin 2\pi t}{\pi t} \cdot \frac{\sin 2\pi t}{\pi t}$$

$$Y_1(\omega) = \frac{1}{4} \left[\frac{1}{2\pi} \text{rect}\left(\frac{\omega}{4\pi}\right) * \text{rect}\left(\frac{\omega}{4\pi}\right) \right]$$

$$= \frac{1}{2} \text{Tri}\left(\frac{\omega}{4\pi}\right)$$

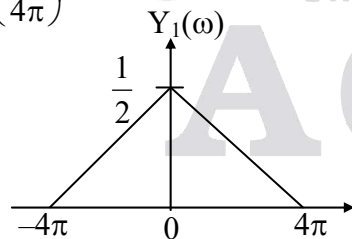

$$y_1(t) \cos 6\pi t \leftrightarrow \frac{1}{2} [Y_1(\omega - 6\pi) + Y_1(\omega + 6\pi)]$$

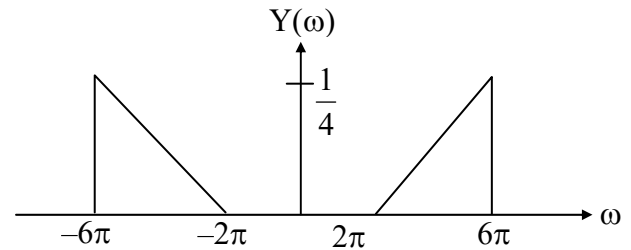
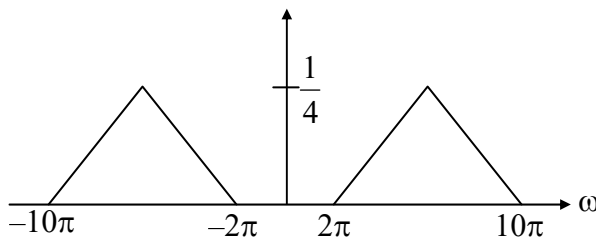

29. **Ans: (c)**

Sol: $e^{-\pi t^2} \leftrightarrow e^{-\pi f^2}$

From frequency shifting property

$$x(t) = e^{j2\pi t} e^{-\pi t^2} \quad \because x^*(-t) = x(t)$$

-conjugate even symmetry

30.

Sol:

(a) $Y(\omega) = \frac{1}{2} [X(\omega - \omega_0) + X(\omega + \omega_0)]$

(b) $x(t) = \frac{\sin t}{\pi t} \cdot \frac{\sin(t/2)}{\pi t}$

$$X(\omega) = \frac{1}{2\pi} \left[\text{rect}\left(\frac{\omega}{2}\right) * \pi \text{rect}\left(\frac{\omega}{1}\right) \right]$$

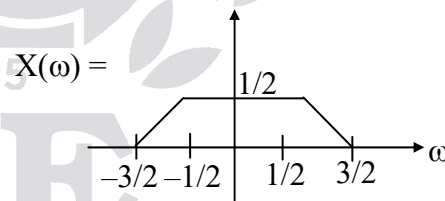

31.

Sol: $\int_{-\infty}^t x(t) dt \leftrightarrow \frac{X(\omega)}{j\omega} + \pi X(0) \delta(\omega)$

$$\leftrightarrow \frac{\text{rect}(\omega/4\pi)}{j\omega} + \pi \delta(\omega)$$

32.

Sol: $\frac{\sin(at)}{\pi t} \leftrightarrow \text{rect}\left(\frac{\omega}{2a}\right)$

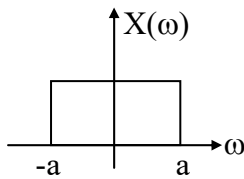

$$E = \frac{1}{2\pi} \int_{-\infty}^{\infty} |X(\omega)|^2 d\omega = \frac{2a}{\pi} = \frac{a}{\pi}$$

33.

$$\text{Sol: } E = \frac{1}{2\pi} \left[\int_{-1}^{-1/2} \pi d\omega + \int_{-1/2}^{1/2} \frac{\pi}{4} d\omega + \int_{1/2}^1 \pi d\omega \right] = \frac{5}{8}$$

34.

$$\text{Sol: } E_{x(t)} = 1/4$$

$$|X(\omega)|^2 = \frac{1}{4 + \omega^2}$$

$$S_{yy}(\omega) = |X(\omega)|^2 |H(\omega)|^2 = \frac{1}{4 + \omega^2}, -\omega_c < \omega < \omega_c$$

$$E_{y(t)} = \frac{1}{2\pi} \int_{-\infty}^{\infty} S_{yy}(\omega) d\omega \Rightarrow \frac{1}{8} = \frac{1}{2\pi} \frac{1}{2} \tan^{-1} \left(\frac{\omega}{2} \right) \Big|_{-\omega_c}^{\omega_c}$$

$$\omega_c = 2 \text{ rad/sec}$$

35.

$$\text{Sol: } e^{-2|t|} \leftrightarrow \frac{4}{\omega^2 + 4}$$

$$\int_{-\infty}^{\infty} \frac{8}{(\omega^2 + 4)^2} d\omega = 2 \int_{-\infty}^{\infty} \left(\frac{4}{\omega^2 + 4} \right)^2 d\omega$$

$$= \frac{1}{2} (2\pi) \int_{-\infty}^{\infty} |e^{-2|t|}|^2 dt$$

$$= \frac{\pi}{2}$$

$$\text{36. Ans: } B = \frac{2.302}{a}$$

$$\text{Sol: } g(t) = \frac{2a}{a^2 + t^2}$$

$$\text{We know } e^{-a|t|} \leftrightarrow \frac{2a}{a^2 + \omega^2}$$

$$\text{By duality property } \frac{2a}{a^2 + t^2} \leftrightarrow e^{-a|\omega|}$$

$$\text{Given } \int_{-B}^B |e^{-a|\omega|}|^2 d\omega = 0.99 \int_{-\infty}^{\infty} |e^{-a|\omega|}|^2 d\omega$$

$$\Rightarrow \int_{-B}^0 e^{2a\omega} d\omega + \int_0^B e^{-2a\omega} d\omega = 0.99 \left[\int_{-\infty}^0 e^{2a\omega} d\omega + \int_0^{\infty} e^{-2a\omega} d\omega \right]$$

$$\Rightarrow \frac{e^{2a\omega}}{2a} \Big|_{-B}^0 + \frac{e^{-2a\omega}}{-2a} \Big|_0^B = 0.99 \left[\frac{e^{2a\omega}}{2a} \Big|_{-\infty}^0 + \frac{e^{-2a\omega}}{-2a} \Big|_0^{\infty} \right]$$

$$\Rightarrow \frac{1}{2a} [1 - e^{-2aB}] - \frac{1}{2a} [e^{-2aB} - 1] = \frac{0.99}{2a} [1 + 1]$$

$$\Rightarrow 2 - 2e^{-2aB} = 2 \times 0.99$$

$$\Rightarrow 1 - e^{-2aB} = 0.99$$

$$\Rightarrow 0.01 = e^{-2aB}$$

$$\Rightarrow \ln(100) = 2aB$$

$$\Rightarrow B = \frac{\ln(100)}{2a} = \frac{4.605}{2a} = \frac{2.302}{a}$$

37. Ans: (a)

$$\text{Sol: } E = \int_{-\infty}^{\infty} |X_1(f)|^2 df = \frac{2}{3} \times 10^{-8}$$

38. Ans: (c)

$$\text{Sol: } \angle H(\omega) = \frac{-\omega}{60} \quad -30\pi < \omega < 30\pi$$

$$\omega_0 = 10\pi \quad |H(10\pi)| = 2, \quad \angle H(10\pi) = \frac{-\pi}{6}$$

$$\omega_0 = 26\pi \quad |H(26\pi)| = 1, \quad \angle H(26\pi) = \frac{-13\pi}{30}$$

$$y(t) = 4 \cos \left(10\pi t - \frac{\pi}{6} \right) + \sin \left(26\pi t - \frac{13\pi}{30} \right)$$

39.

$$\text{Sol: } \theta(\omega) = -\omega t_0$$

$$t_p(\omega) = \frac{-\theta(\omega)}{\omega} = t_0$$

$$t_g(\omega) = \frac{-d\theta(\omega)}{d\omega} = t_0$$

Both are constant

40.

Sol:**(i) Ans: (c)**

$$H(f) = \frac{1}{1 + j2\pi fRC}$$

$$|H(f)| = \frac{1}{\sqrt{1 + 4\pi^2 f^2 R^2 C^2}}$$

$$|H(f_1)| \geq 0.95$$

$$f_1 = 52.2 \text{ Hz}$$

(ii) Ans: (a)

$$\theta(f) = -\tan^{-1}(2\pi fRC)$$

$$t_g(f) = \frac{-d\theta(f)}{df} = \frac{1}{2\pi} \left[\frac{2\pi RC}{1 + (2\pi fRC)^2} \right]$$

$$t_g(100) = 0.71 \text{ msec}$$

41. **Ans: (c)**

$$\text{Sol: } y(t) = \frac{1}{100} \cos(100(t - 10^{-8})) \cos(10^6(t - 1.56 \times 10^{-6}))$$

$$t_g = 10^{-8}, t_p = 1.56 \times 10^{-6}$$

42.

Sol: The condition for distortion less transmission system is magnitude response is constant and phase response is linear function of frequency. These two conditions are satisfied in the frequency range 20 to 30 kHz. So, from 20 to 30kHz no distortion.

43. **Ans: 8**

Sol: Given input signal frequencies are 10Hz, 20Hz, 40Hz. Only 20Hz is allowed.

So, $y(t) =$

$$\frac{1}{2} \times 8 \cos\left(20\pi t + \frac{\pi}{4} - 20^\circ\right) = 4 \cos\left(20\pi t + \frac{\pi}{4} - 20^\circ\right)$$

$$\text{Power in } y(t) = \frac{(4)^2}{2} = 8$$

44.

Sol: The condition for distortion less transmission system is magnitude response is constant and phase response is linear function of frequency.

For $-200 < \omega < 200$, there is no amplitude distortion.

And For $-100 < \omega < 100$, there is no phase distortion

 $x_1(t)$

$$\omega = 20 \text{ and } \omega = 60$$

So no phase distortion and no amplitude distortion.

 $x_2(t)$

$$\omega = 20, \omega = 140$$

Amplitude distortion, do not occurs.

Phase distortion occurs.

$$[\because \omega = 140]$$

 $x_3(t)$

$$\omega = 20, \omega = 220,$$

Phase distortion and amplitude distortion occurs

$$[\because \omega = 220]$$

45.

$$\text{Sol: } R_{xx}(\tau) = \int_0^T x(t)x(t-\tau)dt$$

$$R_{xx}(\tau) = \frac{A^2}{2} \cos(\omega_0 \tau) = 18 \cos(6\pi \tau)$$

$$\text{Power} = R_{xx}(0) = 18$$

46.

$$\text{Sol: } r_{xx}(\tau) = x(t) * x(-t) = e^{-3t} u(t) * e^{3t} u(-t)$$

$$r_{xx}(\tau) \xleftrightarrow{F.T} S_{xx}(\omega) = \frac{1}{9 + \omega^2} \Rightarrow r_{xx}(\tau) = \frac{1}{6} e^{-3|\tau|}$$

47.

Sol:

$$(a) |H(\omega)|^2 = \frac{1}{1 + \omega^2}, |X(\omega)|^2 = \frac{1}{4 + \omega^2}$$

$$S_{YY}(\omega) = |X(\omega)|^2 |H(\omega)|^2$$

(b) $y(t) = x(t) * h(t) = [e^{-t} - e^{-2t}]u(t)$

$$E_{y(t)} = \int_{-\infty}^{\infty} |y(t)|^2 dt = \frac{1}{12}$$

$$E_{x(t)} = \frac{1}{4}$$

$$E_{y(t)} = \frac{1}{3} E_{x(t)}$$

48.

Sol:

i) Ans: (b)

$$x(t) = e^{-8t}u(t) * e^{-8t}u(t) = \frac{1}{16} e^{-8|t|}$$

$$x\left(\frac{1}{16}\right) = \frac{1}{16\sqrt{e}}$$

ii) Ans: (c)

$$S_{GG}(\omega) = |G(\omega)|^2 = \frac{1}{64 + \omega^2}$$

$$S_{GG}(0) = \frac{1}{64}$$

iii) Ans: (b)

$$y(\tau) = e^{-8\tau}u(\tau) * e^{8\tau}u(-\tau)$$

$$y(\tau) = \frac{1}{16} e^{-8|\tau|}$$

$$y(0) = \frac{1}{16}$$

49.

Sol: $r_{xy}(\tau) = x(t) * y(-t) = e^{-t}u(t) * e^{3t}u(-t)$

$$r_{xy}(\tau) \leftrightarrow \frac{1}{1+j\omega} \frac{1}{3-j\omega} = \frac{1/4}{1+j\omega} + \frac{1/4}{3-j\omega}$$

$$r_{xy}(\tau) = \frac{1}{4} e^{-\tau}u(\tau) + \frac{1}{4} e^{3\tau}u(-\tau)$$

50.

Sol: Given $x(t) = \text{sinc } 10t$

$$\text{Sinc } t \leftrightarrow \text{rect}\left(\frac{\omega}{2\pi}\right)$$

$$\text{sinc}(10t) \leftrightarrow \frac{1}{10} \text{rect}\left(\frac{\omega}{20\pi}\right)$$

$$X(\omega) = \frac{1}{10} \text{rect}\left(\frac{\omega}{20\pi}\right)$$

$$H(\omega) = 3 \text{rect}\left(\frac{\omega}{8\pi}\right) e^{-j2\omega}$$

$$\therefore Y(\omega) = X(\omega) H(\omega)$$

$$= \frac{1}{10} \text{rect}\left(\frac{\omega}{20\pi}\right) 3 \text{rect}\left(\frac{\omega}{8\pi}\right) e^{-j2\omega}$$

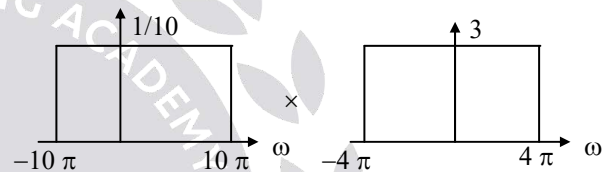

$$= \frac{3}{10} \text{rect}\left(\frac{\omega}{8\pi}\right) e^{-j2\omega}$$

\therefore output energy

$$= \frac{1}{2\pi} \int_{-\infty}^{\infty} |Y(\omega)|^2 d\omega$$

$$= \frac{1}{2\pi} \int_{-4\pi}^{4\pi} \frac{9}{100} d\omega$$

$$= \frac{1}{2\pi} \cdot \frac{9}{100} \times 8\pi$$

$$\text{Output energy} = \frac{36}{100} \text{ J}$$

51.

Sol:

(a) $\omega_m = 200\pi$

$$\omega_s = 400\pi \text{ rad/sec}$$

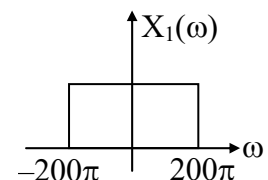

(b) $\omega_m = 400 \pi$
 $\omega_s = 800 \pi \text{ rad/sec}$

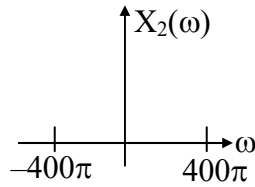

(c) $x_3(t) = \frac{5}{2} [\cos(500\pi t) + \cos(3000\pi t)]$
 $\omega_m = 5000 \pi$
 $\omega_s = 10,000 \pi \text{ rad/sec}$

(d) $X_4(\omega) = \frac{1}{6 + j\omega} \cdot \text{rect}\left(\frac{\omega}{2a}\right)$
 $\omega_m = a$
 $f_m = \frac{a}{2\pi}$
 $f_s = 2f_m = \frac{a}{\pi} \text{ Hz}$

(e) $\omega_m = 120 \pi, f_m = 60 \text{ Hz}$
 $(f_s) = 2f_m = 120 \text{ Hz}$

(f) **Ans: 0.4**
Sol:

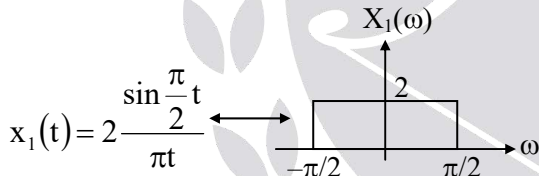

$$\sum_{n=-\infty}^{+\infty} \delta(t - nT_s) \leftrightarrow f_s \sum_{n=-\infty}^{+\infty} \delta(\omega - n\omega_s)$$

$$\sum_{n=-\infty}^{+\infty} \delta(t - 10n) \leftrightarrow \frac{1}{10} \sum_{n=-\infty}^{+\infty} \delta\left(\omega - n \frac{\pi}{5}\right)$$

$$x_1(t) * \sum_{n=-\infty}^{+\infty} \delta(t - 10n) \leftrightarrow X_1(\omega) \frac{1}{10} \sum_{n=-\infty}^{+\infty} \delta\left(\omega - n \frac{\pi}{5}\right)$$

$$X(\omega) = \frac{1}{10} \sum_{n=-\infty}^{+\infty} X_1\left(\frac{n\pi}{5}\right) \delta\left(\omega - n \frac{\pi}{5}\right)$$

$$X(\omega) = \frac{1}{10} \left[\dots + X_1(0)\delta(\omega) + X_1\left(\frac{\pi}{5}\right)\delta\left(\omega - \frac{\pi}{5}\right) + \right.$$

$$\left. X_1\left(\frac{2\pi}{5}\right)\delta\left(\omega - \frac{2\pi}{5}\right) + X_1\left(\frac{3\pi}{5}\right)\delta\left(\omega - \frac{3\pi}{5}\right) + \dots \right]$$

$$X_1\left(\frac{\pi}{5}\right) = 2, X_1\left(\frac{2\pi}{5}\right) = 2,$$

$$X_1\left(\frac{3\pi}{5}\right) = X_1\left(\frac{4\pi}{5}\right) = \dots = 0$$

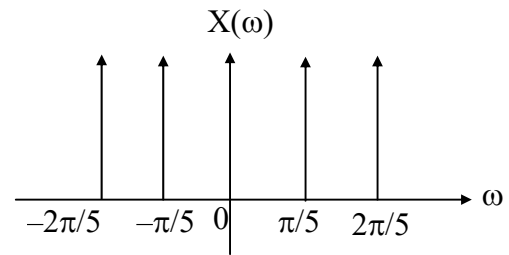

The maximum frequency in above signal is

$$\omega_m = 2\pi/5$$

$$2\pi f_m = 2\pi/5$$

$$f_m = 1/5$$

$$\text{Nyquist rate} = 2f_m = 2/5 = 0.4$$

52.

Sol:

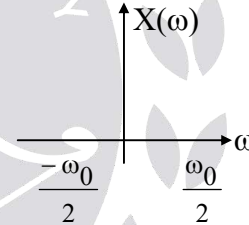

(a) $X(\omega) + e^{-j\omega} X(\omega)$ no change in frequency axis
 $(\omega_s)_{\min} = 2\omega_m = \omega_0$

(b) $\frac{dx(t)}{dt} \leftrightarrow j\omega X(\omega)$

$$\omega_s = \omega_0$$

(c) $x(3t) \leftrightarrow \frac{1}{3} X\left(\frac{\omega}{3}\right)$

$$\omega_s = 2 \times \frac{3\omega_0}{2} = 3\omega_0$$

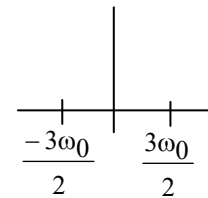

(d) $\frac{1}{2} X(\omega + \omega_0) + \frac{1}{2} X(\omega - \omega_0)$

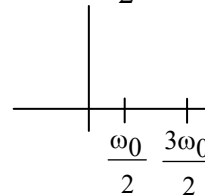

$$\omega_s = 2 \times \frac{3\omega_0}{2} = 3\omega_0$$

53.

Sol:

$$(a) x_1(2t) \leftrightarrow \frac{1}{2} X_1\left(\frac{\omega}{2}\right)$$

In this operation maximum frequency becomes double. So, $f_m = 4k$, $f_s = 2f_m = 8k$

$$(b) x_2(t-3) \leftrightarrow e^{-3j\omega} X_2(\omega)$$

In this operation maximum frequency does not change double. So, $f_m = 3k$, $f_s = 2f_m = 6k$

$$(c) X_1(\omega) + X_2(\omega)$$

In this operation maximum frequency is $\max(2k, 3k)$. So, $f_m = 3k$, $f_s = 2f_m = 6k$

$$(d) X_1(\omega) * X_2(\omega)$$

In this operation maximum frequency is $2k + 3k$. So, $f_m = 5k$, $f_s = 2f_m = 10k$

$$(e) X_1(\omega) X_2(\omega)$$

In this operation maximum frequency is $\min(2k, 3k)$. So, $f_m = 2k$, $f_s = 2f_m = 4k$

$$(f) \frac{1}{2} [X_1(\omega + 1000\pi) + X_1(\omega - 1000\pi)]$$

$$f_m = 2.5\text{kHz}, (f_s)_{\min} = 2f_m = 5\text{kHz}$$

54. Ans: (d)

Sol: Given $x(t) = 100 \cos(24\pi \times 10^3 t)$

$$f_m = 12000\text{Hz} \ \& \ f_s = \frac{1}{50\mu} = 20\text{KHz}$$

The frequencies in sampled signal are $= n f_s \pm f_m = 12K, 8K, 32K, 52K, 28K, \dots$

The above frequencies passed through a filter of cutoff from 15K.

So, output is 8KHz, 12KHz only.

55. Ans: (a)

Sol: $f_m = 200\text{Hz}$, $f_s = 300\text{Hz}$

The frequency in sampled signals are = 200, 100, 500, 400, 800.

Cutoff frequency of filter is 100 Hz.

Output frequency = 100 Hz

56. Ans: (b)

Sol: The sampled signal spectrum is

$$X_\delta(f) = \frac{1}{T_s} \sum_{n=-\infty}^{\infty} X(f - n f_s)$$

If $f_s = f_m \rightarrow$ The spectrum is constant spectrum

57. Ans: (a)

Sol: $f_m < f_c < f_s - f_m \Rightarrow 5 < f_c < 9$

58. Ans: (c)

Sol: $f_m = 100$, $f_s - f_m = 150$

$$f_s = 250$$

$$T_s = \frac{1}{f_s} = 4\text{m sec}$$

59. Ans: (d)

Sol: $f_s = \frac{1}{T_0} = \frac{1}{10^{-3}} = 10^3 = 1\text{kHz}$

$$C_n = \frac{1}{T_0} \int_{-T_0/6}^{T_0/6} 3e^{-jn\omega_0 t} dt = \frac{\sin\left(\frac{n\pi}{3}\right)}{n\pi}$$

$$\therefore C_n = 0 \text{ for } n = 3, 6, 9 \dots$$

$$C_n \neq 0 \text{ for } n = 0, 1, 2, 4, 6, 7, 8, 10 \dots$$

$$\therefore \pm f \pm 3f_s, \quad + f \pm 6 f_s \dots$$

Are not present in signal

$$\pm 400 \pm 3(1000) = \pm 3.4 \text{ K}, \pm 2.6 \text{ K}$$

So options with 3.4 K and 2.6 K are wrong

So (c) and (a) are wrong.

3.6 K is out of the given range [2.5 to 3.5]

So (B) is wrong

So (D) is correct.

60.

(i) Ans: (b)

Sol:

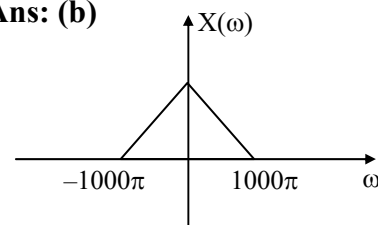

Output of multiplier is $= x(t) \cdot \cos(1000\pi t)$
 $= \frac{1}{2} X(\omega - 1000\pi) + \frac{1}{2} X(\omega + 1000\pi)$

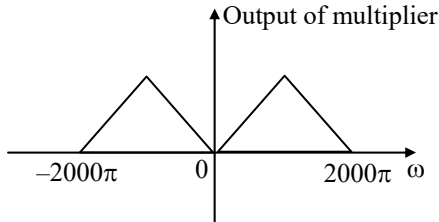

$$h(t) = \frac{\sin(1500\pi t)}{\pi t}$$

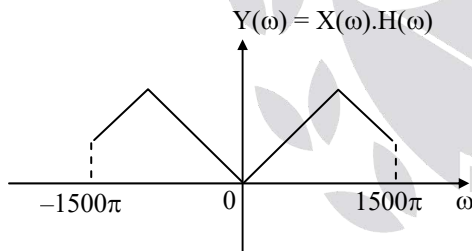
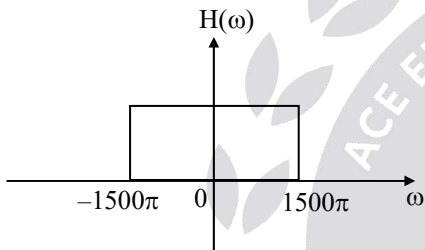

The maximum frequency in $y(t) = 1500 \pi$

$$\omega_m = 1500 \pi$$

$$f_n = 750$$

$$(f_s)_{\min} = 2f_n = 1500 \text{ Hz}$$

$$= 1500 \text{ samples/sec}$$

(ii) **Ans: (a)**

Sol: $x(t) = \cos\left(10\pi t + \frac{\pi}{4}\right)$

$$f_s = 15 \text{ Hz}, \omega_s = 2\pi f_s = 30 \pi \text{ Hz}$$

$$h(t) = \left(\frac{\sin \pi t}{\pi t}\right) \cdot \cos\left(40\pi t - \frac{\pi}{2}\right)$$

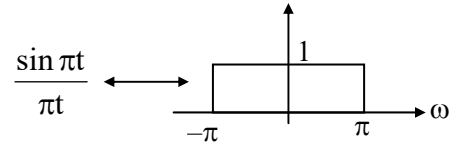

$$h(t) = \frac{\sin \pi t}{\pi t} \left[\cos(40\pi t) \cos \frac{\pi}{2} + \sin 40\pi t \sin \frac{\pi}{2} \right]$$

$$h(t) = \frac{\sin \pi t}{\pi t} \cdot \sin 40\pi t$$

$$= \frac{1}{2j} \left[\frac{\sin \pi t}{\pi t} \cdot e^{j40\pi t} - \frac{\sin \pi t}{\pi t} \cdot e^{-j40\pi t} \right]$$

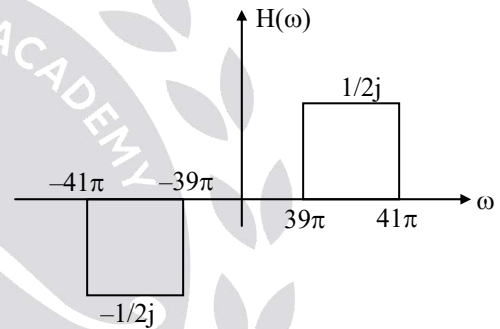

$$x(t) = \cos(10\pi t) \cos \frac{\pi}{4} - \sin(10\pi t) \sin \frac{\pi}{4}$$

$$X(\omega) = \frac{1}{\sqrt{2}} \left[\pi(\delta(\omega + 10\pi) + \delta(\omega - 10\pi)) \right]$$

$$- \frac{1}{\sqrt{2}} \left[\frac{\pi}{j} (\delta(\omega - 10\pi) - \delta(\omega + 10\pi)) \right]$$

Sampled signal spectrum

$$X_s(\omega) = f_s \sum_{n=-\infty}^{\infty} X(\omega - n\omega_s)$$

$$n = 0, \omega_m, -\omega_m = -10\pi, 10\pi$$

$$n = 1, \omega_s - \omega_m, \omega_s + \omega_m = 20\pi, 40\pi$$

$$n = 2, 2\omega_s - \omega_m, 2\omega_s + \omega_m = 50\pi, 70\pi$$

only 40π frequency is allowed output of filter is

$$Y(\omega) = \frac{15}{\sqrt{2}} \left[\frac{-\pi}{2j} \delta(\omega + 40\pi) + \frac{\pi}{2j} \delta(\omega - 40\pi) \right]$$

$$- \frac{15}{\sqrt{2}} \left[\frac{\pi}{j} \times \frac{1}{2j} \delta(\omega - 40\pi) - \frac{\pi}{j} \left(\frac{-1}{2j} \right) \delta(\omega + 40\pi) \right]$$

$$\begin{aligned}
 &= \frac{15}{\sqrt{2}} \left[-\frac{\pi}{2j} \delta(\omega + 40\pi) + \frac{\pi}{2j} \delta(\omega - 40\pi) \right] \\
 &\quad - \frac{15}{\sqrt{2}} \left[\frac{-\pi}{2} \delta(\omega - 40\pi) - \frac{\pi}{2} \delta(\omega + 40\pi) \right] \\
 &= \frac{15}{\sqrt{2}} \left[-\frac{\pi}{2j} \delta(\omega + 40\pi) + \frac{\pi}{2j} \delta(\omega - 40\pi) \right. \\
 &\quad \left. + \frac{\pi}{2} \delta(\omega - 40\pi) + \frac{\pi}{2} \delta(\omega + 40\pi) \right] \\
 Y(\omega) &= \frac{15}{\sqrt{2}} \left[\frac{\pi}{2} [\delta(\omega + 40\pi) + \delta(\omega - 40\pi)] \right. \\
 &\quad \left. + \frac{\pi}{2j} [\delta(\omega - 40\pi) - \delta(\omega + 40\pi)] \right] \\
 y(t) &= \frac{15}{\sqrt{2}} \left[\frac{1}{2} \cos 40\pi t + \frac{1}{2} \sin 40\pi t \right] \\
 y(t) &= \frac{15}{2} \left[\cos 40\pi t \cos \frac{\pi}{4} + \sin 40\pi t \sin \frac{\pi}{4} \right] \\
 y(t) &= \frac{15}{2} \cos \left(40\pi t - \frac{\pi}{4} \right)
 \end{aligned}$$

61. Ans: (c)

Sol: $x(t) = m(t) c(t)$

Where $c(t)$ is carrier signal and $m(t)$ is a base band signal and $f_c > f_H$ (where f_c is carrier frequency, f_H is the highest frequency component of $m(t)$)

$$\hat{x}(t) = m(t) \hat{c}(t)$$

Where $\hat{f}(t)$ is Hilbert transform of $f(t)$.

For the above problem $c(t) = \sin\left(\pi t - \frac{\pi}{4}\right)$

$$\text{and } m(t) = -\sqrt{2} \left(\frac{\sin(\pi t / 5)}{\pi t / 5} \right)$$

Complex envelope

$$= [x(t) + j\hat{x}(t)] e^{-j2\pi f_c t}$$

$$= -\sqrt{2} \left[m(t) \sin\left(\pi t - \frac{\pi}{4}\right) - j m(t) \cos\left(\pi t - \frac{\pi}{4}\right) \right] e^{-j2\pi f_c t}$$

$$= -\sqrt{2} m(t) \left[\cos\left(\pi t - \frac{\pi}{4}\right) + j \sin\left(\pi t - \frac{\pi}{4}\right) \right] e^{-j2\pi f_c t}$$

$$\begin{aligned}
 &= -\sqrt{2} m(t) e^{+j\left(\pi t - \frac{\pi}{4}\right)} \cdot e^{-j2\pi\left(\frac{1}{2}\right)t} \\
 &= j\sqrt{2} m(t) e^{-j\frac{\pi}{4}} = \sqrt{2} m(t) e^{-\frac{j\pi}{4}} \\
 &= \sqrt{2} \left(\frac{\sin(\pi t / 5)}{\pi t / 5} \right) e^{j\frac{\pi}{4}}
 \end{aligned}$$

62. Ans: (b)

Sol: Given $s(t) = e^{-at} \cos[(\omega_c + \Delta\omega)t] u(t)$

Complex Envelope $\tilde{s}(t) = s_+(t) e^{-j\omega_c t}$

$$\tilde{s}(t) = [e^{-at} e^{j(\omega_c + \Delta\omega)t} u(t)] e^{-j\omega_c t}$$

Complex Envelope = $e^{-at} e^{j\Delta\omega t} u(t)$

63. Ans: 8

Sol: $Y(\omega) = X(\omega) H(\omega)$

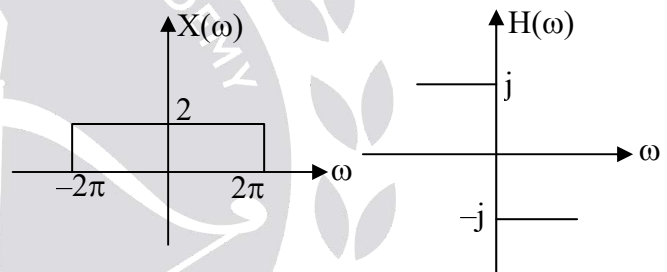

$$\begin{aligned}
 Y(\omega) &= -2j \quad 0 < \omega < 2\pi \\
 &= 2j \quad -2\pi < \omega < 0
 \end{aligned}$$

$$\int_{-\infty}^{\infty} |y(t)|^2 dt = \frac{1}{2\pi} \int_{-\infty}^{\infty} |y(\omega)|^2 d\omega$$

$$= \frac{1}{2\pi} \left[\int_0^{2\pi} 4 d\omega + \int_{-2\pi}^0 4 d\omega \right]$$

$$= \frac{4}{2\pi} [2\pi + 2\pi]$$

$$= \frac{16\pi}{2\pi}$$

$$= 8$$

64. Ans: 10 kHz

Sol: $m(t) \rightarrow$ band limited to 5kHz

$m(t) \cos(40000\pi t) \rightarrow$ modulated signal we require least sampling rate to recover

$m(t) \rightarrow 2 \times 5\text{kHz} = 10\text{ kHz}$

65. Ans: (c)

Sol: Aliasing occurs when the sampling frequency is less than twice the maximum frequency in the signal, and it is irreversible process.

So, Statement I is true but Statement II is false.

66. Ans: (b)

Sol: Sampling in one domain makes the signal to be periodic in the other domain. It is true.

Multiplication in one domain is the convolution in the other domain.

Both statements are correct and statement (II) is not the correct explanation of statement (I).



Chapter 5 Laplace Transform

01.

Sol: $e^{-at}u(t) \leftrightarrow \frac{1}{s+a}, \sigma > -a$

$e^{at}u(-t) \leftrightarrow \frac{-1}{s-a}, \sigma < a$

$e^{-at}u(-t) \leftrightarrow \frac{-1}{s+a}, \sigma > -a$

(1) $X_1(s) = \frac{1}{s+1} + \frac{1}{s+3}, \sigma > -1$

(2) $X_2(s) = \frac{1}{s+2} - \frac{1}{s-4}, -2 < \sigma < 4$

(3) no common ROC so no laplace transform for $x_3(t)$.

(4) no common ROC, no laplace transform

(5) no common ROC, no laplace transform

(6) $X_6(s) = \frac{1}{s+1} - \frac{1}{s-1}, -1 < \sigma < 1$

02.

Sol: ROC = $(\sigma > -5) \cap (\sigma > \text{Re}(-\beta)) = \sigma > -3$
Imaginary part of 'β' any value, real part of 'β' is 3.

03.

Sol: The possible ROC's are
 $\sigma > 2, \sigma < -3, -3 < \sigma < -1, -1 < \sigma < 2$

04.

Sol: $Y(s) = \frac{e^{-3s}}{s+1} - \frac{e^{-3s}}{s+2}$

$y(t) = e^{-(t-3)} \cdot u(t-3) - e^{-2(t-3)} \cdot u(t-3)$

05.

Sol:

(a) $x(t) = e^{-5(t-1)} \cdot u(t-1) \cdot e^{-5} \leftrightarrow X(s) = \frac{e^{-s} \cdot e^{-5}}{s+5}, \sigma > -5$

(b) $g(t) = Ae^{-5t} \cdot u(-t-t_0)$

$G(s) = \frac{-A \cdot e^{(s+5)t_0}}{s+5}, \sigma < -5$

$A = -1, t_0 = -1$

06.

Sol:

(a) $x(t) = 5r(t) - 5r(t-2) - 15u(t-2) + 5u(t-4)$

$X(s) = \frac{5}{s^2} - \frac{5e^{-2s}}{s^2} - \frac{15e^{-2s}}{s} + \frac{5e^{-4s}}{s}$

(b) Ans: (a)

Sol: $x(t) = r(t) - r(t-1) - r(t-4) + 1.5r(t-6) - 0.5r(t-8)$

$X(s) = \frac{1}{s^2} - \frac{e^{-s}}{s^2} - \frac{e^{-4s}}{s^2} + \frac{3e^{-6s}}{2s^2} - \frac{1e^{-8s}}{2s^2}$

So, $D = -\frac{1}{2} = -0.5$

07.

Sol: $Y(s) = \frac{4(s^2 - e^{-s})}{(s+1)(s+2)}$

$\frac{s^2+3s+2}{-3s-2} \left(\frac{1}{s^2+3s+2} \right)$

$= 4 \left[1 + \frac{(-3s-2)}{(s+1)(s+2)} \right] - \frac{4e^{-s}}{(s+1)(s+2)}$

$Y(s) = 4 \left[1 + \frac{1}{s+1} - \frac{4}{s+2} \right] - 4e^{-s} \left[\frac{1}{s+1} - \frac{1}{s+2} \right]$

↓ I.L.T

$y(t) = 4\delta(t) + 4e^{-t}u(t) - 16e^{-2t}u(t) - 4e^{-(t-1)}u(t-1) + 4e^{-2(t-1)}u(t-1)$

08. Ans: (c)

Sol: $X(s) = \frac{1}{(s+1)(s+3)}$

$$G(s) = X(s-2) = \frac{1}{(s-1)(s+1)}$$

$G(\omega)$ converges means ROC include $j\omega$ axis $-1 < \sigma < 1$.

09.

Sol: $G(s) = X(s) + \alpha X(-s)$, where $X(s) = \frac{\beta}{s+1}$

$$G(s) = \frac{\beta s - \beta - \alpha \beta s - \alpha \beta}{s^2 - 1} = \frac{s}{s^2 - 1}$$

$$\alpha \beta - \beta = -1, -\beta - \alpha \beta = 0$$

$$\alpha = -1, \beta = \frac{1}{2}$$

10.

Sol: $\frac{dy(t)}{dt} = -2y(t) + \delta(t)$ $\frac{dy(t)}{dt} = 2x(t)$

$$sY(s) = -2Y(s) + 1 \quad \text{----- (1)}$$

$$sY(s) = 2X(s) \quad \text{----- (2)}$$

solving (1) and (2)

$$Y(s) = \frac{2}{s^2 + 4}, X(s) = \frac{s}{s^2 + 4}$$

11.

Sol: (a) $X(s) = \frac{-4}{s+2} + \frac{4}{(s+1)^3} - \frac{4}{(s+1)^2} + \frac{4}{s+1}$

$$x(t) = -4e^{-2t} \cdot u(t) + 4 \frac{t^2}{2} e^{-t} \cdot u(t)$$

$$-4te^{-t} \cdot u(t) + 4e^{-t} \cdot u(t)$$

(b) $X(s) = -\frac{e^{-2s}}{(s+1)^3}$

$$x(t) = -(t-2)^2 \cdot e^{-(t-2)} \cdot u(t-2)$$

$$\frac{t^2}{2} e^{-t} u(t) \leftrightarrow \frac{1}{(s+1)^3}$$

12.

Sol: $y(t) + y(t) * x(t) = x(t) + \delta(t)$

$$Y(s) + Y(s)X(s) = X(s) + 1$$

$$Y(s) = 1$$

$$y(t) = \delta(t)$$

13.

Sol: $x_1(t-2) \leftrightarrow \frac{e^{-2s}}{s+2}, \sigma > -2$

$$x_2(-t+3) \leftrightarrow \frac{e^{-3s}}{-s+3}, \sigma < 3$$

$$Y(s) = \frac{e^{-2s}}{s+2} \cdot \frac{e^{-3s}}{-s+3}, -2 < \sigma < 3$$

14.

Sol: $sY(s) + 4Y(s) + 3\frac{Y(s)}{s} = X(s)$

$$H(s) = \frac{s}{(s+1)(s+3)} = \frac{-1}{s+1} + \frac{3}{s+3}$$

$$h(t) = \frac{-1}{2} e^{-t} \cdot u(t) + \frac{3}{2} e^{-3t} \cdot u(t)$$

$$X(s) = \frac{1}{s} + 1 = \frac{s+1}{s}$$

$$Y(s) = X(s) \cdot H(s) = \frac{1}{s+3}$$

$$y(t) = e^{-3t} \cdot u(t)$$

15. **Ans: (d)**

Sol: $X(s) = \frac{1}{s+2} + e^{-6s}, H(s) = \frac{1}{s}$

$$Y(s) = X(s) \cdot H(s) = \frac{1}{s(s+2)} + \frac{e^{-6s}}{s}$$

$$y(t) = \frac{1}{2} [u(t) - e^{-2t} \cdot u(t)] + u(t-6)$$

16. **Ans: (b)**

Sol: $H(s) = \frac{1}{s+5}$

$$Y(s) = \frac{1}{s+3} - \frac{1}{s+5} = \frac{2}{(s+3)(s+5)}$$

$$X(s) = \frac{Y(s)}{H(s)} = \frac{2}{s+3}$$

$$x(t) = 2 e^{-3t} u(t)$$

17. **Ans: (b)**

Sol: $\frac{V(s)}{X(s)} = \frac{1}{s+1}$ $\frac{Y(s)}{V(s)} = \frac{1}{s+1}$

$$H(s) = \frac{Y(s)}{X(s)} = \frac{1}{s+1} \cdot \frac{1}{s+1} = \frac{1}{(s+1)^2}$$

$$h(t) = t e^{-t} \cdot u(t)$$

18.

Sol: $y(t) = x(t) * h(t) = e^{-t} u(t) * \sin t u(t)$

$$\begin{aligned} &\downarrow_{L.T} \\ Y(s) &= \frac{1}{(s^2+1)(s+1)} = \frac{A}{s+1} + \frac{Bs+C}{s^2+1} \\ &= \frac{1/2}{s+1} + \frac{-1/2s + 1/2}{s^2+1} \end{aligned}$$

$$\begin{aligned} &\downarrow_{I.L.T} \\ y(t) &= \frac{1}{2} e^{-t} u(t) - \frac{1}{2} \cos t u(t) + \frac{1}{2} \sin t u(t) \end{aligned}$$

19.

Sol: $s^2 Y(s) + \alpha s Y(s) + \alpha^2 Y(s) = X(s)$

$$H(s) = \frac{1}{s^2 + \alpha s + \alpha^2}$$

$$G(s) = \frac{\alpha^2}{s} H(s) + s H(s) + \alpha H(s)$$

$$G(s) = \left[\frac{\alpha^2 + s^2 + s\alpha}{s} \right] \left[\frac{1}{s^2 + \alpha s + \alpha^2} \right] = \frac{1}{s}$$

Number of poles = 1.

20. **Ans: (d)**

Sol: Change the initial condition to $-2y(0)$ and the forcing function to $-2x(t)$

21.

Sol: (a) $x(0) = \lim_{s \rightarrow \infty} s X(s) = 2$

$$x(\infty) = \lim_{s \rightarrow 0} s X(s) = 0$$

(b) $X(s) = \frac{4s+5}{2s+1}$ improper function

$$X(s) = 2 + \frac{3}{2s+1} = \frac{3}{2s+1}$$

neglect the constant '2' in the above function.

$$x(0) = \lim_{s \rightarrow \infty} s \cdot \frac{3}{2s+1} = \frac{3}{2}$$

$$x(\infty) = \lim_{s \rightarrow 0} s X(s) = \lim_{s \rightarrow 0} \frac{4s^2 + 5s}{2s+1} = 0$$

(c) $x(0) = 0$

Final value theorem not applicable, because poles on imaginary axis.

(d) $x(0) = 0$

$$x(\infty) = -1$$

22.

Sol: $H(s) = \frac{k(s+1)}{(s+2)(s+4)}$ $X(s) = \frac{1}{s}$

$$Y(s) = H(s) X(s) = \frac{k(s+1)}{s(s+2)(s+4)}$$

$$y(\infty) = \lim_{s \rightarrow 0} s Y(s) = \frac{k}{8} = 1 \Rightarrow k = 8$$

$$H(s) = \frac{-4}{s+2} + \frac{12}{s+4}$$

$$h(t) = -4e^{-2t} u(t) + 12e^{-4t} u(t)$$

23.

Sol: $H(j\omega) = \frac{j\omega - 2}{(j\omega)^2 + 4j\omega + 4}$

$$x(t) = 8 \cos 2t, \omega_0 = 2$$

$$H(j\omega_0) = \frac{j-1}{4j} = \frac{1}{4} + \frac{1}{4}j$$

$$|H(\omega_0)| = \frac{1}{2\sqrt{2}}, \angle H(\omega_0) = \frac{\pi}{4}$$

$$y(t) = \frac{8}{2\sqrt{2}} \cos\left(2t + \frac{\pi}{4}\right) = 2\sqrt{2} \cos\left(2t + \frac{\pi}{4}\right)$$

24. **Ans: (a)**

Sol: $H(j\omega) = \frac{-\omega^2 + 1}{-\omega^2 + 2j\omega + 1}$

$$\omega_0 = 1 \text{ rad/sec}$$

$$H(\omega_0) = 0$$

$$y(t) = 0 \text{ for all } \omega_s$$

25.

Sol:

(i) **Ans: (d)**

$$H(s) = \frac{2}{s^2 - s - 2} \quad X(s) = \frac{1}{s}$$

$$Y(s) = X(s)H(s) = \frac{2}{s(s+1)(s-2)}$$

S = 2 pole lies right side of s-plane

$y(\infty) = \infty$ unbounded

(ii) **Ans: 0.5**

$$H(s) = \frac{1}{s}$$

$$x(t) = \frac{\sin t}{\pi t} u(t)$$

$$\sin t u(t) \leftrightarrow \frac{1}{s^2 + 1}$$

$$\frac{\sin t u(t)}{t} \leftrightarrow \int_s^\infty \frac{1}{s^2 + 1} ds = \tan^{-1}(s) \Big|_s^\infty$$

$$= \frac{\pi}{2} - \tan^{-1}(s)$$

$$X(s) = \frac{1}{\pi} \left[\frac{\pi}{2} - \tan^{-1}(s) \right]$$

$$= \frac{1}{2} - \frac{1}{\pi} \tan^{-1}(s)$$

$$H(s) = \frac{Y(s)}{X(s)}$$

$$\Rightarrow Y(s) = X(s)H(s) = \left[\frac{1}{2} - \frac{1}{\pi} \tan^{-1}(s) \right] \frac{1}{s}$$

$$y(\infty) = \lim_{s \rightarrow 0} sY(s) = \lim_{s \rightarrow 0} \left[\frac{1}{2} - \frac{1}{\pi} \tan^{-1}(s) \right]$$

$$= \frac{1}{2}$$

26. **Ans: (d)**

Sol: For an LTI system input and output frequencies must be same, there may be change in phase.

Given that input is $a_1 \sin(\omega_1 t + \phi_1)$ and corresponding output is $a_2 F(\omega_2 t + \phi_2)$.

From the above condition F may be sin or cos and $\omega_1 = \omega_2$.

27.

Sol: Given $X(s) = \frac{s+2}{s-2}$

$$y(t) = -\frac{2}{3} e^{2t} u(-t) + \frac{1}{3} e^{-t} u(t)$$

$$Y(s) = \frac{2}{3} \cdot \frac{1}{s-2} + \frac{1}{3} e^{-t} u(t)$$

$$Y(s) = \frac{2}{3} \cdot \frac{1}{s-2} + \frac{1}{3} \cdot \frac{1}{s+1}$$

$$\Downarrow \quad \Downarrow$$

$$\sigma < 2 \quad \sigma > -1$$

(a) $\therefore H(s) = \frac{Y(s)}{X(s)}$

$$= \frac{1}{3} \left[\frac{2(s+1) + s - 2}{(s-2)(s+1)} \right] \sigma < 2, \sigma > -1, \sigma > 0$$

$$= \frac{1}{3} \left[\frac{s+2}{s-2} \right] \sigma > -1$$

$$= \frac{1}{3} \frac{3s}{(s+1)(s+2)}$$

$$= \frac{s}{(s+1)(s+2)}, \sigma > -1$$

(b) The input is $e^{3t} \forall t$

\therefore the output = $H(3) \times$ input

$$= \frac{3}{4 \times 5} e^{3t}$$

$$y(t) = \frac{3}{20} e^{3t}$$

28.

Sol: $H(s) = \frac{s^2 + s - 2}{s + 3}$

$$H_{\text{inv}}(s) = \frac{1}{H(s)} = \frac{s + 3}{(s + 2)(s - 1)}$$

$\sigma > +1$ causal unstable

Does not exist in this case a causal & stable system.

29. **Ans: (c)**

Sol:

(a) A system to be stable & causal all the poles of the system should lie in the left half of s-plane.

(b) Any system property like causality, stability doesn't depend on the location of zero's. It depends only on poles location.

(c) There is no necessity that the poles lie within $|s| = 1$

All the roots of characteristic equation means all the poles of the system should lie in left half of s-plane.

30. **Ans: (a)**

Sol: $Y(s) = \frac{1}{s + 2}, H(s) = \frac{s - 1}{s + 1}$

$$X(s) = \frac{Y(s)}{H(s)} = \frac{s + 1}{(s - 1)(s + 2)} = \frac{2/3}{s - 1} + \frac{1/3}{s + 2}$$

Stable input $-2 < \sigma < 1$

$$x(t) = -\frac{2}{3} e^t u(-t) + \frac{1}{3} e^{-2t} u(t)$$

31. **Ans: -2.19**

Sol: $Y(s) = 1 - \frac{4}{s + 6}$

$$y(t) = \delta(t) - 4 e^{-6t} u(t)$$

$$y(0.1) = -4 e^{-0.6} = -2.19$$

32. **Ans: (a, c & d)**

Chapter 6 Discrete Time Fourier Transform

01.
Sol:

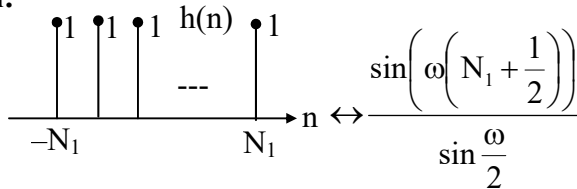

$$(a) H(\omega) = \frac{\sin\left(\frac{7\omega}{2}\right)}{\sin\left(\frac{\omega}{2}\right)}$$

Here $N_1 = 3$

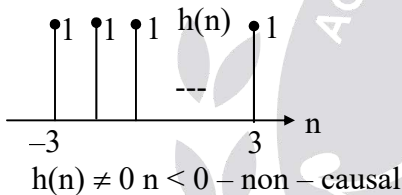

(b)

Here $N_1 = 1$

After applying time shifting property

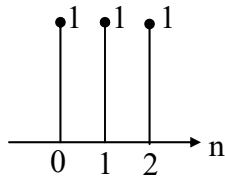

$h(n) = 0 \quad n < 0$ causal

(c) $h(n) = \delta(n-3) + \delta(n+2)$ - non causal

02.

Sol: (a) $a^n u(n) \leftrightarrow \frac{1}{1 - ae^{-j\omega}}$

$$y(n) = \left(\frac{1}{4}\right)^n u(n)$$

$$Y(e^{j\omega}) = \frac{1}{1 - \frac{1}{4}e^{-j\omega}}$$

$$Y(e^{j0}) = \frac{1}{1 - \frac{1}{4}} = \frac{4}{3}$$

$$(b) X(e^{j\omega}) = \sum_{n=-\infty}^{\infty} x(n)e^{-j\omega n}$$

$$\omega = \pi$$

$$X(e^{j\pi}) = \sum_{n=-\infty}^{\infty} x(n)(-1)^n = \cos^3(3\pi) = -1$$

$$(c) H(e^{j\omega}) = 1 + 2e^{-j\omega} + 3e^{-2j\omega} + 4e^{-3j\omega}$$

$$\text{DC gain } H(e^{j0}) = 1 + 2 + 3 + 4 = 10$$

03.

Sol:

$$(i) X(e^{j\omega}) = 1 + e^{j\omega} + e^{-j\omega} + \frac{3}{2}[1 + \cos 2\omega]$$

$$X(e^{j\omega}) = 1 + e^{j\omega} + e^{-j\omega} + \frac{3}{2}\left[1 + \frac{e^{2j\omega} + e^{-2j\omega}}{2}\right]$$

$$X(e^{j\omega}) = 1 + e^{j\omega} + e^{-j\omega} + \frac{3}{2} + \frac{3}{4}e^{2j\omega} + \frac{3}{4}e^{-2j\omega}$$

$$X(e^{j\omega}) = \sum_{n=-\infty}^{\infty} x(n)e^{-j\omega n}$$

$$x(0) = 1 + \frac{3}{2} = \frac{5}{2}, \quad x(1) = 1, \quad x(-1) = 1,$$

$$x(2) = \frac{3}{4}, \quad x(-2) = \frac{3}{4}$$

$$x(n) = \left[\frac{3}{4}, 1, \frac{5}{2}, 1, \frac{3}{4}\right]$$

↑

$$(ii) x(n) = 2\delta(n+3) - 3\delta(n-3)$$

$$X(e^{j\omega}) = 2e^{3j\omega} - 3e^{-3j\omega} = 2[e^{3j\omega} - e^{-3j\omega}] - e^{-3j\omega}$$

$$X(e^{j\omega}) = 4j\sin(3\omega) - e^{-3j\omega}$$

$$\text{Given } X(e^{j\omega}) = a\sin(b\omega) + ce^{jd\omega}$$

$$a = 4j, \quad b = 3, \quad c = -1, \quad d = -3$$

04.

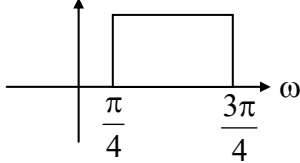
Sol: $\frac{\sin\left(\frac{\pi}{4}n\right)}{\pi n} \cdot e^{j\frac{\pi}{2}n} \leftrightarrow$ 

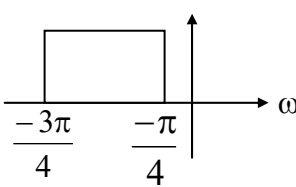
$\frac{\sin\left(\frac{\pi}{4}n\right)}{\pi n} \cdot e^{-j\frac{\pi}{2}n} \leftrightarrow$ 

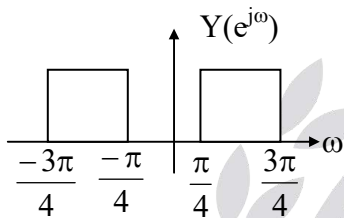

$$Y(e^{j\omega}) = \frac{\sin\left(\frac{\pi n}{4}\right)}{\pi n} \left[e^{j\frac{\pi}{2}n} + e^{-j\frac{\pi}{2}n} \right]$$

$$y(n) = 2 \frac{\sin\left(\frac{\pi n}{4}\right)}{\pi n} \cos\left(\frac{\pi n}{2}\right)$$

05. Sol:

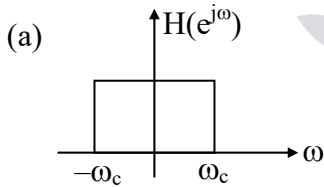

$$g(n) = (-1)^n \cdot h(n)$$

$$G(e^{j\omega}) = H(e^{j(\omega-\pi)})$$

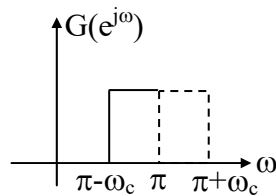

Ideal HPF

(b) $Y(e^{j\omega}) = X(e^{j\omega}) + X(e^{j(\omega-\pi)})$

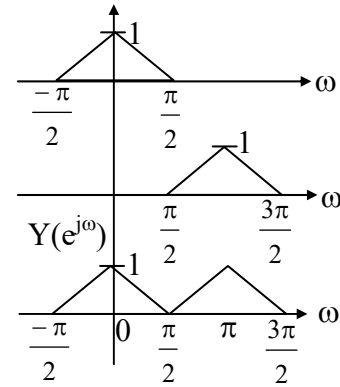

$$Y(e^{j0}) = 1, Y(e^{j\pi}) = 1$$

06.

Sol: $\left(\frac{1}{2}\right)^n u(n) \leftrightarrow \frac{1}{1 - \frac{1}{2}e^{-j\omega}}$

From time scaling property

$$\left(\frac{1}{2}\right)^{10} u\left(\frac{n}{10}\right) \leftrightarrow \frac{1}{1 - \frac{1}{2}e^{-j10\omega}}$$

07. Ans: (b)

Sol: $x(2n) = \{1, 3, 1\}$

$$x(2n) = \delta(n+1) + 3\delta(n) + \delta(n-1)$$

$$\delta(n - n_0) \leftrightarrow e^{-j\omega n_0}$$

FT $[x(2n)] = 3 + 2\cos\omega$

08.

Sol:

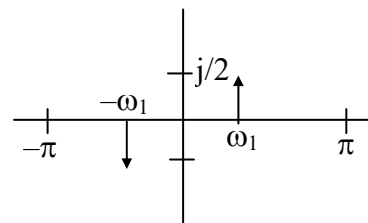

$$X(e^{j\omega}) = \frac{-j}{2} \delta(\omega + \omega_1) + \frac{j}{2} \delta(\omega - \omega_1)$$

$$1 \leftrightarrow 2\pi\delta(\omega)$$

$$1 \cdot e^{j\omega_0 n} \leftrightarrow 2\pi\delta(\omega - \omega_0)$$

By applying inverse DTFT

$$\begin{aligned} x(n) &= \frac{1}{2\pi} \left[\frac{-j}{2} e^{j(-\omega_1)n} + \frac{j}{2} e^{j\omega_1 n} \right] \\ &= \frac{1}{2\pi} \left[\frac{1}{2j} e^{-j\omega_1 n} - \frac{1}{2j} e^{j\omega_1 n} \right] \\ &= -\frac{1}{2\pi} \sin \omega_1 n \end{aligned}$$

09.

Sol: $\alpha^n u(n) \leftrightarrow \frac{1}{1 - \alpha e^{-j\omega}}$

$$\alpha^{n-3} u(n-3) \leftrightarrow \frac{e^{-3j\omega}}{1 - \alpha e^{-j\omega}}$$

$$e^{jn\frac{\pi}{8}} \alpha^{n-3} u(n-3) \leftrightarrow \left[\frac{e^{-3j(\omega-\pi/8)}}{1 - \alpha e^{-j(\omega-\pi/8)}} \right]$$

$$ne^{jn\frac{\pi}{8}} \alpha^{n-3} u(n-3) \leftrightarrow j \frac{d}{d\omega} \left[\frac{e^{-3j(\omega-\pi/8)}}{1 - \alpha e^{-j(\omega-\pi/8)}} \right]$$

10.

Sol:

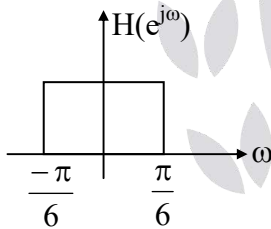

Input signal frequencies are $\frac{\pi}{8}, \frac{\pi}{4}$

Then the output is $y(n) = \sin\left(\frac{\pi}{8}n\right)$

11.

Sol: For an LTI system input is $x(n) = e^{j\omega_0 n}$

then output is $y(n) = e^{j\omega_0 n} \cdot H(e^{j\omega_0})$

$$H(e^{j\omega}) = \sum_{n=-\infty}^{\infty} h(n) e^{-j\omega n}$$

$$H(e^{j\omega}) = 8\sqrt{2} \cos 2\omega - 4\sqrt{2} \cos \omega$$

$$\omega_0 = \frac{\pi}{4}$$

$$H(e^{j\omega_0}) = -4 \quad y(n) = -4e^{jn\frac{\pi}{4}}$$

12.

Sol: (a) $y_1(n) = x_1^2(n)$ it is not an LTI system.

(b) Input frequency and output frequency are same. So, it is LTI system.

$$H(e^{j\omega}) = 2$$

(c) $y_3(n) = x_3(2n)$ it is not an LTI system.

13.

Sol: $H(e^{j\omega}) = 2\alpha \cos \omega + \beta$

$$H(e^{j\omega}) \Big|_{\omega=\frac{2\pi}{3}} = 0 \quad H(e^{j\omega}) \Big|_{\omega=\frac{2\pi}{8}} = 1$$

$$\alpha = \beta \quad \alpha\sqrt{2} + \beta = 1$$

$$\beta = \frac{1}{1 + \sqrt{2}}$$

$$\text{DC gain} = H(e^{j0}) = 3\alpha = \frac{3}{1 + \sqrt{2}}$$

14.

Sol: $H(e^{j\omega}) = \frac{b + e^{-j\omega}}{1 - ae^{-j\omega}}$

$$|H(e^{j\omega})|^2 = 1 \Rightarrow H(e^{j\omega}) \cdot H^*(e^{j\omega}) = 1$$

$$\left[\frac{b + e^{-j\omega}}{1 - ae^{-j\omega}} \right] \left[\frac{b + e^{j\omega}}{1 - ae^{j\omega}} \right] = 1$$

Only when $a = -b$

15. **Ans: (a)**

Sol: $H(e^{j\omega}) = 1 + \alpha e^{-j\omega} + \beta e^{-2j\omega}$

$$x(n) = 1 + 4\cos n\pi$$

$$x_1(n) = 1 \quad \omega = 0$$

$$|H(e^{j0})| = 1 + \alpha + \beta \quad \angle H(e^{j0}) = 0$$

$$y_1(n) = 1 + \alpha + \beta$$

$$x_2(n) = 4\cos n\pi \quad \omega = \pi$$

$$|H(e^{j\pi})| = 1 - \alpha + \beta \quad \angle H(e^{j\pi}) = 0$$

$$y_2(n) = 4(1 - \alpha + \beta)\cos n\pi$$

$$y(n) = (1 + \alpha + \beta) + 4(1 - \alpha + \beta)\cos n\pi$$

$$y(n) = 4 \text{ only when } \alpha = 2, \beta = 1$$

16. Ans: (a)

Sol: $Y(e^{j0}) = \sum_{n=0}^2 x(n) \cdot \sum_{n=0}^4 h(n) = 15LB$

17.

Sol: $y(n) = x(n) + 2x(n-1) + x(n-2)$

$Y(e^{j\omega}) = X(e^{j\omega}) [1 + 2e^{-j\omega} + e^{-2j\omega}]$

$H(e^{j\omega}) = [1 + e^{-j\omega}]^2$

$= [1 + \cos \omega - j \sin \omega]^2$

(a) $|H(e^{j\omega})| = |2 + 2\cos \omega|$

$\angle H(e^{j\omega}) = -\omega$

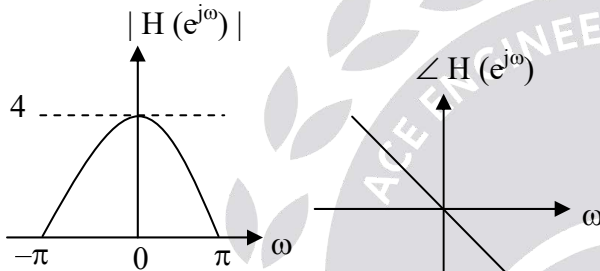

(b) Output of given input $10 + 4 \cos\left(\frac{\pi n}{2} + \frac{\pi}{4}\right)$ is

$x(n) = 10, H(e^{j\omega}) = 4$

$y(n) = 40$

$= 40 + 4(2)\cos\left(\frac{\pi n}{4} + \frac{\pi}{4} - \frac{\pi}{2}\right)$

$= 40 + 8\cos\left(\frac{\pi n}{4} - \frac{\pi}{4}\right)$

18. Ans: (b)

Sol: Anti symmetric, $k = -2$

$\theta(\omega) = -2\omega$

Slope = -2

19. Ans: (b)

Sol: $x(n) = \cos\left(\frac{5\pi}{2}n\right) = \cos\left(\frac{\pi}{2}n\right) \quad \omega_0 = \frac{\pi}{2}$

$|H(e^{j\omega})| = 1 \quad \angle H(e^{j\omega_0}) = -\frac{\pi}{8}$

$y(n) = \cos\left(\frac{n\pi}{2} - \frac{\pi}{8}\right)$

20. Ans: (b)

Sol:

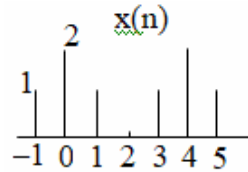

$x(n)$ is symmetric about $n = 2$

$\angle X(e^{j\omega}) = -2\omega$

$\angle X(e^{j\pi/4}) = -2\left(\frac{\pi}{4}\right) = -\frac{\pi}{2}$

21. Ans: 3

Sol: $X(e^{j\omega}) = \frac{6}{4 - 2e^{-j\omega}} = \frac{6/4}{1 - \frac{1}{2}e^{-j\omega}}$

↓ I.F.T

$x(n) = \frac{3}{2} \left(\frac{1}{2}\right)^n u(n)$

$E_{x(n)} = \sum_{n=-\infty}^{+\infty} |x(n)|^2 = \sum_{n=0}^{\infty} \left(\frac{3}{2}\right)^2 \left(\frac{1}{2}\right)^{2n}$

$= \frac{9}{4} \sum_{n=0}^{\infty} \left(\frac{1}{4}\right)^n$

$= \frac{9}{4} \left[\frac{1}{1 - 1/4} \right] = 3$

22.

Sol:

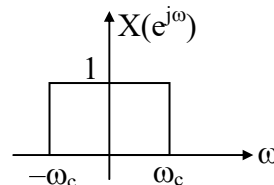

$E = \frac{1}{2\pi} \int_{-\omega_c}^{\omega_c} 1 d\omega = \frac{\omega_c}{\pi}$

23.

Sol:

(a) Ans: $\frac{1}{40}$

By Plancherl's relation

$$\sum_{n=-\infty}^{\infty} x(n)y(n) = \frac{1}{2\pi} \int_{-\pi}^{\pi} X(e^{j\omega})Y(e^{j\omega})d\omega$$

$$x(n) = \frac{\sin\left(\frac{n\pi}{4}\right)}{2\pi n} = \frac{1}{2} \left[\frac{\sin\left(\frac{n\pi}{4}\right)}{\pi n} \right]$$

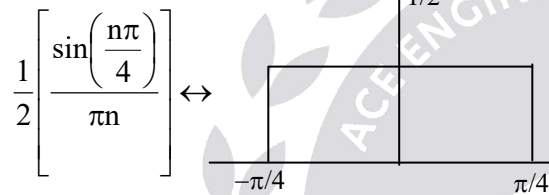

$$y(n) = \frac{1}{5} \left[\frac{\sin\left(\frac{n\pi}{3}\right)}{\pi n} \right]$$

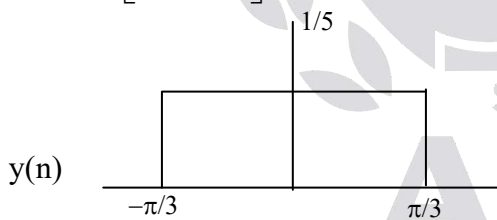

$$\sum_{n=-\infty}^{\infty} \frac{\sin \frac{n\pi}{4}}{2\pi n} \times \frac{\sin \frac{n\pi}{3}}{5\pi n} = \frac{1}{2\pi} \int_{-\pi}^{\pi} \left(\frac{1}{2}\right) \left(\frac{1}{5}\right) d\omega$$

$$= \frac{1}{40}$$

(b) Ans: 8

$$x(n) = 2^{n-1} u(-n+2)$$

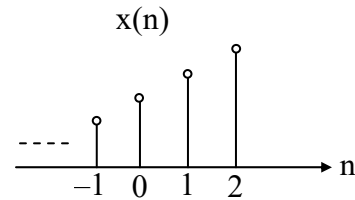

$$y(n) = 2^{-n+2} u(n+1)$$

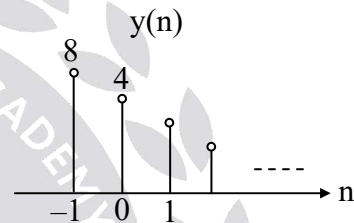

Use Plancherl's theorem

$$\frac{1}{2\pi} \int_0^{2\pi} X(e^{j\omega})Y(e^{-j\omega})d\omega = \sum_{n=-\infty}^{+\infty} x(n)y(n)$$

$$= \sum_{n=-1}^2 2^{n-1} \cdot 2^{-n+2}$$

$$= \sum_{n=-1}^2 2 = 2 + 2 + 2 + 2$$

$$= 8$$

24.

Sol:

(a) $X(e^{j0}) = \sum_{n=-\infty}^{\infty} x(n) = 6$

(b) $X(e^{j\pi}) = \sum_{n=-\infty}^{\infty} (-1)^n x(n) = 2$

(c) $\int_{-\pi}^{\pi} X(e^{j\omega})d\omega = 2\pi x(0) = 4\pi$

$$(d) \int_{-\pi}^{\pi} X(e^{j\omega}) e^{2j\omega} d\omega = 2\pi x(2) = 0$$

$$(e) \int_{-\pi}^{\pi} |X(e^{j\omega})|^2 d\omega = 2\pi \left[\sum_{n=-\infty}^{\infty} |x(n)|^2 \right] = 28\pi$$

$$(f) \int_{-\pi}^{\pi} \left| \frac{d}{d\omega} X(e^{j\omega}) \right|^2 d\omega = 2\pi \left[\sum_{n=-\infty}^{\infty} |nx(n)|^2 \right]$$

$$= 158 \times 2\pi = 316\pi$$

$$(g) \angle X(e^{j\omega}) = -\alpha\omega = -2\omega \quad (\alpha = 2)$$

25. Ans: (d)

Sol: $f(n) = h(n) * h(n)$

	1	2	2
1	1	2	2
2	2	4	4
2	2	4	4

$$f(n) = \{ \underset{\uparrow}{1}, 4, 8, 8, 4 \} \Rightarrow \text{causal}$$

$$g(n) = h(n) * h(-n)$$

$$h(-n) = \{ 2, 2, \underset{\uparrow}{1} \}$$

↑

$$h(-n) \text{ ranges from } n = -2 \text{ to } n = 0$$

$$h(n) \text{ ranges from } n = 0 \text{ to } n = 2$$

$$\therefore g(n) \text{ ranges from } n = -2 \text{ to } n = 2$$

	1	2	2
2	2	4	4
2	2	4	4
1	1	2	2

$$g(n) = \{ 2, 6, \underset{\uparrow}{9}, 6, 2 \}$$

$\Rightarrow g(n)$ is non causal and maximum value is 9.

26.

$$\text{Sol: } \frac{2\pi \times 5k}{40k} \leq \omega \leq \frac{2\pi \times 10k}{40k}$$

$$F_s = 2f_m$$

$$= 2 \times 20k$$

$$= 40kHz$$

$$\frac{\pi}{4} \leq \omega \leq \frac{\pi}{2}$$

27. Ans: (a)

Sol: $x(t) = \cos(\Omega_0 t)$

$$x(nT_s) = \cos(\Omega_0 nT_s) = \cos\left(\frac{\Omega_0 n}{1000}\right) \text{----- (1)}$$

$$\text{Given } x(n) = \cos\left(\frac{n\pi}{4}\right) = \cos\left(\frac{9\pi n}{4}\right) \text{----- (2)}$$

By comparing (1) & (2)

$$\frac{\Omega_0}{1000} = \frac{\pi}{4} ; \quad \frac{\Omega_0}{1000} = \frac{9\pi}{4}$$

$$\Omega_0 = 250\pi, \quad 2250\pi$$

28. Ans: 2.25 kHz

Sol: $H(e^{j\omega}) = 0.5 + 0.5e^{-j\omega}$

$\omega = \frac{\pi}{2}$ is 3 - dB cutoff frequency

$$\omega = \frac{2\pi f}{f_s} = \frac{\pi}{2}$$

$$\frac{2\pi f}{9kHz} = \frac{\pi}{2}$$

$$f = 2.25kHz$$

Chapter

7

Z - Transform

01.

Sol: $a^n u(n) \leftrightarrow \frac{z}{z-a}, |z| > |a|$

$-a^n u(-n-1) \leftrightarrow \frac{z}{z-a}, |z| < |a|$

ROC = $(|z| > 1) \cap (|z| < |\alpha|) = 1 < |z| < 2$

Only when $\alpha = \pm 2$, 'n₀' any value

02.

Sol: (a) finite duration both sided signal $0 < |z| < \infty$

(b) finite duration right sided signal $|z| > 0$

(c) infinite duration right sided signal

$(|z| > 1/2) \cap (|z| > 3/4) = |z| > 3/4$

(d) $(|z| > 1/3) \cap (|z| < 3) \cap (|z| > 1/2) = 1/2 < |z| < 3$

03. **Ans: (a)**

Sol: ROC = $(|z| > |a|) \cap (|z| < |b^2|)$ common ROC exists only when $|a| < |b^2|$

04. **i) Ans: (b)**

Sol: ROC = $(|z| > |a|) \cap (|z| > |b|) \cap (|z| < |c|)$
 $= |b| < |z| < |c|$

ii) ROC = $(|z| > |\alpha|) \cap (|z| < |\beta|)$

$X(z) = \frac{z}{z-\alpha} - \frac{z}{z-\beta}$

(a) $\alpha > \beta$ no Z.T

(b) $\alpha < \beta$ Z.T is exist

(c) $\alpha = \beta$ no Z.T

05. **Ans: (c)**

Sol: $X(z) = \frac{-1/2}{1 - \frac{1}{2}z^{-1}} + \frac{3/2}{1 + \frac{1}{2}z^{-1}}$

$x(n) = -\frac{1}{2} \left(\frac{1}{2}\right)^n u(n) + \frac{3}{2} \left(\frac{-1}{2}\right)^n u(n)$

$x(2) = 1/4$

06. **Ans: (d)**

Sol: poles = j, -j, zeros = 0, 0

$X(z) = \frac{kz^2}{z^2 + 1}$

$X(1) = 1 \Rightarrow k = 2$

$X(z) = \frac{2z^2}{z^2 + 1}$

Given right sided sequence so ROC is

$|z| > |\pm j| \Rightarrow |z| > 1$

$X(z) = \frac{2z^2}{z^2 + 1}$, ROC is $|z| > 1$

07. **Ans: (b)**

Sol: $X(z) = \sum_{n=0}^{\infty} \frac{3^n}{2+n} z^{2n}$
 $= \frac{1}{2} + z^2 + \frac{9}{4} z^4 + \dots$

$x(n) = \left\{ \begin{matrix} \dots, \frac{9}{4}, 0, 1, 0, \frac{1}{2} \\ \uparrow \end{matrix} \right\}$

Now consider (a) option

$Y_1(z) = \sum_{n=0}^{\infty} \left(\frac{2}{3}\right)^n z^{-n}$
 $= 1 + \frac{2}{3} z^{-1} + \frac{9}{4} z^{-2} + \dots$

$\sum_{n=-\infty}^{\infty} x(n) y_1(n) \neq 0$

Now consider option (b)

$Y_2(z) = z^{-1} + 4z^{-3} + \dots$

$y_2(n) = \{0, 1, 0, 4, \dots\}$

$\sum_{n=-\infty}^{\infty} x(n) y_2(n) = 0$

08. Ans: $r = -1/2$

$$\text{Sol: } H(z) = \frac{1}{1 - \frac{1}{2}z^{-1}} + \frac{r}{1 + \frac{1}{4}z^{-1}} = \frac{1 + \frac{1}{4}z^{-1} + r(1 - \frac{1}{2}z^{-1})}{(1 - \frac{1}{2}z^{-1})(1 + \frac{1}{4}z^{-1})}$$

Consider the numerator

$$1 + \frac{1}{4}z^{-1} + r\left(1 - \frac{1}{2}z^{-1}\right)$$

$$(1+r) + \left(\frac{1}{4} - \frac{r}{2}\right)z^{-1}$$

$$\text{zero} = \frac{-\left(\frac{1}{4} - \frac{r}{2}\right)}{1+r}$$

If zero = 1

$$\frac{1 - \frac{r}{2}}{1+r} = 1 \Rightarrow \frac{1}{4} - \frac{r}{2} = 1+r$$

$$\frac{-3r}{2} = \frac{3}{4} \Rightarrow r = -1/2$$

If zero = -1

$$\frac{1 - \frac{r}{2}}{1+r} = -1 \Rightarrow \frac{1}{4} - \frac{r}{2} = -1-r$$

$$\frac{r}{2} = \frac{-5}{4} \Rightarrow r = -5/2 \text{ is not valid}$$

Because given as $|r| < 1$

09. Ans: (a)

$$\text{Sol: } H(z) = \frac{z^4}{z^4 + \frac{1}{4}}$$

$$H(z) \neq H(z^{-1})$$

$$h(n) \neq h(-n)$$

$\therefore h(n)$ is not even.

$$x\left(\frac{n}{m}\right) \leftrightarrow X(z^m)$$

$$\frac{z^4}{z^4 + \frac{1}{4}} \leftrightarrow \left(-\frac{1}{4}\right)^{n/4} u\left(\frac{n}{4}\right)$$

So $h(n)$ is real for all 'n'

10.

$$\text{Sol: } (-3)^n \cdot u(n-2) \leftrightarrow \frac{9z^{-1}}{z+3}, |z| > 3$$

$$(-3)^{-n} \cdot u(-n-2) \leftrightarrow \frac{9z}{z^{-1}+3}, |z| < \frac{1}{3}$$

11.

$$\text{Sol: } g(n) = \delta(n) - \delta(n-6)$$

$$G(z) = 1 - z^{-6}, |z| > 0$$

12.

$$\text{Sol: } X(z) = z^2 + 2z + \frac{2z}{z-2}$$

$$x(n) = \delta(n+2) + 2\delta(n+1) - 2(2)^n u(-n-1)$$

13. Ans: 0.097

Sol: The poles of $H(z)$ are

$$P_k = \frac{1}{\sqrt{2}} \exp\left(\frac{j(2k-1)\pi}{4}\right) \quad k = 1, 2, 3, 4$$

$$P_1 = \frac{1}{\sqrt{2}} e^{j\frac{\pi}{4}} = \frac{1}{2} + \frac{j}{2} = \frac{1+j}{2}$$

$$P_2 = \frac{1}{\sqrt{2}} e^{j\frac{3\pi}{4}} = \frac{-1}{2} + \frac{j}{2}$$

$$P_3 = \frac{1}{\sqrt{2}} e^{j\frac{5\pi}{4}} = -\frac{1}{2} - \frac{j}{2}$$

$$P_4 = \frac{1}{\sqrt{2}} e^{j\frac{7\pi}{4}} = \frac{1}{2} - \frac{j}{2}$$

$$H(z) = \frac{kz^4}{(z-P_1)(z-P_2)(z-P_3)(z-P_4)}$$

$$= \frac{kz^4}{z^4 + \frac{1}{4}}$$

Given $H(1) = 5/4$

$$\frac{5}{4} = \frac{k}{5/4}$$

$$k = \frac{25}{16}$$

$$H(z) = \frac{\frac{25}{16}z^4}{z^4 + \frac{1}{4}}$$

Given $g(n) = (j)^n h(n)$

$$G(z) = H(z/j)$$

$$G(z) = \frac{\frac{25}{16} \left(\frac{z}{j}\right)^4}{\left(\frac{z}{j}\right)^4 + \frac{1}{4}} = \frac{\frac{25}{16}z^4}{z^4 + \frac{1}{4}}$$

$$G(z) = \frac{25}{16} - \frac{25}{64}z^{-4} + \frac{25}{256}z^{-8} + \dots$$

$$g(8) = \frac{25}{256} = 0.097$$

14.

Sol: $x(n) = \left(\frac{5}{4}\right)^n u(n) + \left(\frac{10}{7}\right)^n u(-n)$

$$\left(\frac{5}{4}\right)^n u(n) \leftrightarrow \frac{z}{z - \frac{5}{4}}, \quad |z| > 5/4$$

$$\left(\frac{7}{10}\right)^n u(n) \leftrightarrow \frac{z}{z - \frac{7}{10}}, \quad |z| > \frac{7}{10}$$

$$\left(\frac{7}{10}\right)^{-n} u(-n) \leftrightarrow \frac{z^{-1}}{z^{-1} - \frac{7}{10}}, \quad |z^{-1}| > \frac{7}{10}$$

$$\left(\frac{10}{7}\right)^n u(-n) \leftrightarrow \frac{\frac{1}{z}}{\frac{1}{z} - \frac{7}{10}}, \quad |z| < \frac{10}{7}$$

$$X(z) = \frac{z}{z - \frac{5}{4}} + \frac{\frac{1}{z}}{\frac{1}{z} - \frac{7}{10}} \quad \text{ROC}$$

$$\left(|z| > \frac{5}{4} \cap |z| < \frac{10}{7}\right)$$

$$\text{ROC} = \frac{5}{4} < |z| < \frac{10}{7}$$

15.

Sol: $X(z) = z^4 + z^2 - 2z + 2 - 3z^{-4}$

$$H(z) = 2z^{-3}$$

$$Y(z) = X(z)H(z) = 2z + 2z^{-1} - 4z^2 + 4z^{-3} - 6z^{-7}$$

$$y(4) = 0$$

16.

Sol: $x_1(n+3) \leftrightarrow \frac{z^3}{1 - \frac{1}{2}z^{-1}}, |z| > \frac{1}{2}$

$$x_2(-n+1) \leftrightarrow \frac{z^{-1}}{1 - \frac{1}{3}z}, |z| < 3$$

$$Y(z) = \frac{z^2}{\left(1 - \frac{1}{2}z^{-1}\right)\left(1 - \frac{1}{3}z\right)}, \frac{1}{2} < |z| < 3$$

17.

Sol: Causal system $H(z) = \frac{1 - z^{-1}}{1 + \frac{3}{4}z^{-1}}; |z| > \frac{3}{4}$

Input z-transform

$$X(z) = \frac{1}{1 - \frac{1}{3}z^{-1}} - \frac{1}{1 - z^{-1}}; \frac{1}{3} < |z| < 1$$

$$Y(z) = X(z)H(z)$$

$$= \frac{-\frac{2}{3}z^{-1}}{\left(1 - \frac{1}{3}z^{-1}\right)\left(1 + \frac{3}{4}z^{-1}\right)}; |z| > \frac{3}{4}$$

$$= -\frac{\frac{8}{13}}{1 - \frac{1}{3}z^{-1}} + \frac{\frac{8}{13}}{1 + \frac{3}{4}z^{-1}}$$

↓ I.Z.T

$$y(n) = -\frac{8}{13}\left(\frac{1}{3}\right)^n u(n) + \frac{8}{13}\left(-\frac{3}{4}\right)^n u(n)$$

18.

Sol:

$$h(n) = \delta(n) - \delta(n-1) \quad x(n) = (-1)^n u(n)$$

$$H(z) = 1 - z^{-1} \quad X(z) = \frac{1}{1+z^{-1}}$$

$$Y(z) = X(z)H(z) = \frac{1-z^{-1}}{1+z^{-1}}$$

↓ I.Z.T

$$y(n) = (-1)^n u(n) - (-1)^{n-1} u(n-1)$$

19.

Sol: $y(n) - 0.25 y(n-2) = x(n)$

↓ Z.T

$$H(z) = \frac{Y(z)}{X(z)} = \frac{1}{1-0.25z^{-2}}$$

$$x(n) = \underbrace{2}_{\substack{\omega=0 \\ \downarrow \\ z=1}} + \underbrace{\cos\left(\frac{n\pi}{2}\right)}_{\substack{\omega=\frac{\pi}{2} \\ \downarrow \\ z=j}} \rightarrow H(z) = \frac{1}{1-0.25z^{-2}}$$

$$H(z)|_{z=1} = \frac{1}{1-0.25} = \frac{1}{\frac{3}{4}} = \frac{4}{3}$$

$$H(z)|_{z=j} = \frac{1}{1+0.25} = \frac{1}{\frac{5}{4}} = \frac{4}{5}$$

$$\therefore y(n) = 2\left(\frac{4}{3}\right) + \frac{4}{5} \cos\left(\frac{n\pi}{2}\right)$$

20.

Sol: (1) $x(n) = z_0^n, y(n) = z_0^n H(z_0)$

$$y(n) = (-2)^n \cdot H(-2) = 0$$

$$H(-2) = 0$$

$$(2) H(z) = \frac{Y(z)}{X(z)} = \frac{1+a \cdot \frac{1}{1-\frac{1}{4}z^{-1}}}{\frac{1}{1-\frac{1}{2}z^{-1}}}$$

$$(a) H(-2) = 0$$

$$a = \frac{-9}{8}$$

$$(b) y(n) = (1)^n \cdot H(1)$$

$$H(1) = -1/4$$

$$y(n) = \frac{-1}{4}(1)^n$$

21. Ans: (a)

Sol: $y(n) = h(n) * g(n)$

$$Y(e^{j\omega}) = H(e^{j\omega}) G(e^{j\omega})$$

$$\Rightarrow Y(e^{j\omega}) = \frac{G(e^{j\omega})}{\left[1 - \frac{1}{2}e^{-j\omega}\right]}$$

$$\Rightarrow G(e^{j\omega}) = Y(e^{j\omega}) - \frac{1}{2}e^{-j\omega} Y(e^{j\omega})$$

$$\Rightarrow g(n) = y(n) - \frac{1}{2}y(n-1)$$

Put $n = 1$

$$\Rightarrow g(1) = y(1) - \frac{1}{2}y(0) = \frac{1}{2} - \frac{1}{2}$$

$$g(1) = 0$$

22. Ans: (c)

Sol: $H(e^{j\omega}) = 1 - e^{-6j\omega} = 0$ only when

$$6\omega = 2\pi n \quad (n = 1)$$

$$\omega = \frac{\pi}{3}$$

$$\frac{2\pi \times f}{9k} = \frac{\pi}{3}$$

$$f = 1.5k$$

23.

Sol: $X(z) = \frac{0.5}{1 - 2z^{-1}}, |z| < 2$

$$x(n) = -0.5 (2)^n \cdot u(-n-1)$$

$$x(0) = 0$$

24.

Sol: $x(n) = \begin{cases} 1 & n \text{ even} \\ 0 & n \text{ odd} \end{cases}$

$$\Rightarrow X(z) = 1 + z^{-2} + z^{-4} + \dots$$

$$= \frac{1}{1 - z^{-2}}$$

$$= \frac{1}{(1 - z^{-1})(1 + z^{-1})}$$

$$x(\infty) = \lim_{z \rightarrow 1} (1 - z^{-1}) X(z)$$

$$= \lim_{z \rightarrow 1} (1 - z^{-1}) \frac{1}{(1 + z^{-1})(1 - z^{-1})}$$

$$= \frac{1}{2}$$

25.

Sol:

$$(a) \quad h(n) = \frac{\delta(n) + \delta(n-1) + \delta(n-2)}{10}$$

$$H(z) = \frac{1 + z^{-1} + z^{-2}}{10} = \frac{z^2 + z + 1}{10z^2}$$

2 finite poles, 2 finite zeros

(b) Given $x(n) = u(n)$

$$X(z) = \frac{1}{1 - z^{-1}}$$

$$Y(z) = H(z) X(z) = \frac{(1 + z^{-1} + z^{-2})}{10(1 - z^{-1})}$$

$$y(\infty) = \lim_{z \rightarrow 1} (1 - z^{-1}) Y(z)$$

$$= \lim_{z \rightarrow 1} (1 - z^{-1}) \left[\frac{1 + z^{-1} + z^{-2}}{10} \right] \left[\frac{1}{1 - z^{-1}} \right]$$

$$y(\infty) = \frac{1 + 1 + 1}{10} = \frac{3}{10}$$

26. Ans: (a)

Sol: The output of the sampling process is

$$x(nT_s) = 2 + 5 \sin(100 \times \pi \times n \times T_s)$$

$$T_s = \frac{1}{400}$$

$$x(n) = 2 + 5 \sin \left(100 \times \pi \times n \times \frac{1}{400} \right)$$

$$x(n) = 2 + 5 \sin \left(\frac{n\pi}{4} \right), \quad \omega_0 = \frac{\pi}{4}$$

$$N_0 = \frac{2\pi}{\omega_0} m = \frac{2\pi}{\frac{\pi}{4}} m$$

$$N_0 = 8 m$$

$N_0 = 8$ is the No. of samples per cycle

$$\frac{Y(z)}{X(z)} = \frac{1}{N} \left[\frac{1 - z^{-N}}{1 - z^{-1}} \right]$$

$$N = 8$$

$$Y(z) = \frac{1}{8} \left[\frac{1 - z^{-8}}{1 - z^{-1}} \right] X(z)$$

Final value theorem

$$y(\infty) = \lim_{z \rightarrow 1} (1 - z^{-1}) Y(z)$$

$$y(\infty) = \lim_{z \rightarrow 1} (1 - z^{-1}) \frac{1}{8} \left[\frac{1 - z^{-8}}{1 - z^{-1}} \right] X(z)$$

$$y(\infty) = \lim_{z \rightarrow 1} \frac{1 - z^{-8}}{8} X(z)$$

$$y(\infty) = 0$$

27. Ans: (c)

Sol: $Y(z) = H(z)X(z)$

$$= \frac{A}{1-z^{-1}} + \frac{1}{\left(1-\frac{1}{3}z^{-1}\right)(1-z^{-1})}$$

$$y(\infty) = \lim_{z \rightarrow 1} (1-z^{-1})Y(z)$$

$$\Rightarrow A + \frac{3}{2} = 0$$

$$A = \frac{-3}{2}$$

28. Ans: (c)

Sol: $H(z) = \frac{\beta z - 2z^2}{2z^2 - \alpha}$

$$\text{Pole} = \pm \sqrt{\frac{\alpha}{2}}$$

$$\left| \sqrt{\frac{\alpha}{2}} \right| < 1 \Rightarrow |\alpha| < 2, \text{ any value of } \beta$$

29.

Sol:

- (a) An LTI system is stable if and only if ROC includes unit circle.

$$0.5 < |z| < 2$$

- (b) For an LTI system to be causal & stable, all the poles must lie inside the unit circle.

$z = 2$ is the pole lying outside the unit circle.

So it is not possible.

- (c) $|z| > 3$

$$|z| < 0.5$$

$$0.5 < |z| < 2$$

$2 < |z| < 3$ are the four possible ROC's

30. Ans: (d)

Sol: $H(z) = \frac{\left(z - \frac{3}{4}e^{j\theta}\right)\left(z - \frac{3}{4}e^{-j\theta}\right)}{z - \frac{4}{3}}$

Numerator order > denominator order

so, anti-causal system & $|z| < \frac{4}{3}$ - stable

31. Ans: (d)

Sol: Poles $\Rightarrow 1 - 0.5z^{-1} = 0 \Rightarrow z = 0.5$

Zeros $\Rightarrow 1 - 2z^{-1} = 0 \Rightarrow z = 2$

If all zeros and poles are inside the unit circle [$|z| = 1$] then it is a minimum phase system.

So given system is Non minimum phase system if all poles are inside unit circle then we can say system is causal and stable. So given system is stable.

32. Ans: (a)

Sol: $H(z) = -\frac{1}{2} + \frac{1}{2} \frac{z}{z-2}$

Given stable system. So, ROC includes unit circle. ROC is $|z| < 2$

$$h(n) = \frac{-1}{2} \delta(n) - \frac{1}{2} (2)^n u(-n-1)$$

33. Ans: (c)

Sol: Poles $z = \pm 2j$

$$|\text{poles}| = 2$$

ROC = $|z| < 2$ because system is stable (ROC includes unit circle).

In this case system is non-causal.

34. Ans: (d)

Sol: $y(n] - 0.8y[n-1] = x[n] + 1.25x[n+1]$

$$\downarrow_{z.T}$$

$$Y(z) (1 - 0.8z^{-1}) = X(z) (1 + 1.25z)$$

$$\text{T.F } H(z) = \frac{Y(z)}{X(z)} = \frac{1 + 1.25z}{1 - 0.8z^{-1}}$$

$$H(z) = \frac{1}{1 - 0.8z^{-1}} + \frac{1.25z}{1 - 0.8z^{-1}}$$

$\downarrow_{I.Z.T}$

$$h[n] = (0.8)^n u[n] + 1.25(0.8)^{n+1} u[n+1]$$

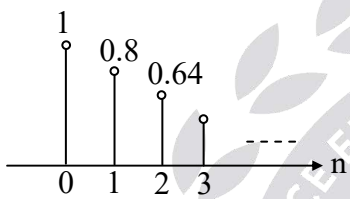

+

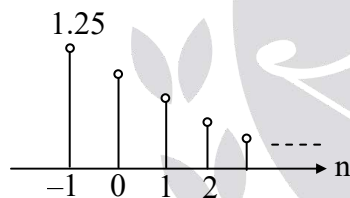

Non-negative samples of impulse response.

35. Ans: (c)

Sol: $H(z) = \frac{z^2 + 1}{(z + 0.5)(z - 0.5)}$

(1) The system is stable because poles $z = \pm 0.5$ are inside the unit circle.

(2) $h(0) = \lim_{z \rightarrow \infty} H(z) = 1$

(3) $\omega = \frac{2\pi f}{f_s} = \frac{2\pi \times \frac{f_s}{4}}{f_s} = \frac{\pi}{2}$

$$H(e^{j\omega}) = \frac{e^{2j\omega} + 1}{(e^{j\omega} + 0.5)(e^{j\omega} - 0.5)} \text{ at } \omega = \frac{\pi}{2} = 0$$

36. Ans: (c)

Sol: A causal LTI system is stable if and only if all of poles of $H(z)$ lie inside the unit circle. So, Assertion (A) is true but Reason (R) is false.

37. Ans: (b)

Sol: $H(z) = \frac{z^3 - 2z^2 + z}{z^2 + \frac{1}{4}z + \frac{1}{8}} = \frac{N(z)}{D(z)}$

As $N(z)$ is of higher order than $D(z)$, the system is not causal, as $\delta[n+1]$ is one of the terms in the output for the input $\delta[n]$.

If the $N(z)$ is of lower order than the denominator, the system

(i) may be causal or

(ii) may not be causal as it depends upon the ROC of the given $H(z)$.

So, Both Statement I and Statement II are individually true but Statement II is not the correct explanation of Statement I

38. Ans: (a)

Sol: Both Statement I and Statement II are individually true and Statement II is the correct explanation of Statement I

39. Ans: (b)

Sol: $H(Z) = \frac{P_0 + P_1 Z^{-1} + P_3 Z^{-3}}{1 + d_3 Z^{-3}}$

Direct Form - I

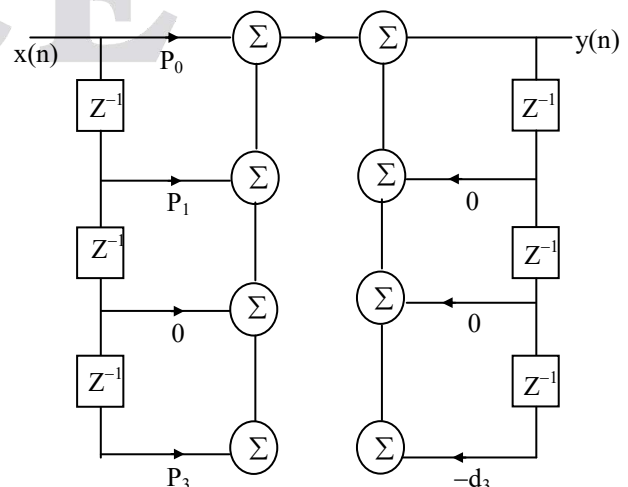

No. of delays = 6
Direct Form – II

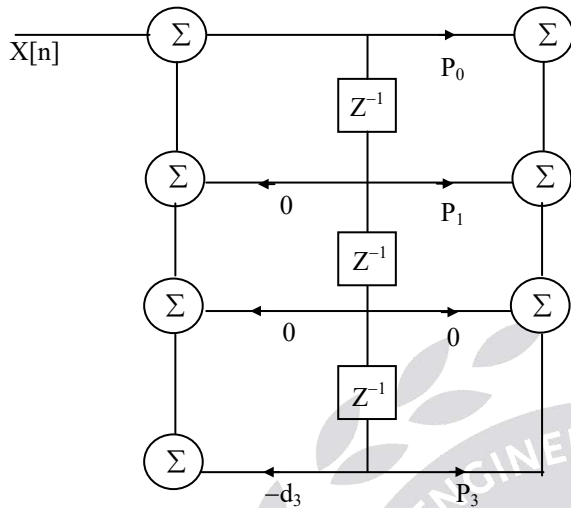

No. of delay's = 3

40.

Sol: $y(n) = x(n-1) \Rightarrow Y(z) = z^{-1} X(z)$

$$H(z) = z^{-1} = H_1(z) H_2(z)$$

$$H_2(z) = z^{-1} \left[\frac{1 - 0.6z^{-1}}{1 - 0.4z^{-1}} \right]$$

41. **Ans: (a)**

Sol: $H(z) = \frac{1}{1 - 0.7z^{-1} + 0.13z^{-2}} \dots\dots (1)$

From the given plot

$$H(z) = \frac{a_0}{1 - a_1z^{-1} - a_2z^{-2}} \dots\dots\dots (2)$$

By comparing (1) & (2)

$$a_0 = 1, a_1 = 0.7, a_2 = -0.13$$

42.

Sol: $H(z) = \frac{1}{1 - az^{-1}}$

$$h(n) = (a)^n u(n)$$

$$\sum_{n=-\infty}^{\infty} |h(n)| < \infty \text{ stable}$$

$$= \infty \text{ unstable}$$

$$\sum_{n=0}^{\infty} (a)^n = \frac{1}{1-a}, |a| < 1$$

$$= \infty, |a| \geq 1$$

For b, c cases system transit from stable to unstable system.

43.

Sol: From signal flow graph

$$H(z) = \frac{1 - \frac{k}{4}z^{-1}}{1 + \frac{k}{3}z^{-1}}$$

$$\text{Pole} = \left| \frac{-k}{3} \right| < 1$$

$$|k| < 3$$

44. **Ans: (c)**

Sol: From signal below graph reduction

$$H(z) = \frac{2 + z^{-1}}{1 + 2z^{-1}}$$

$$= \frac{2z + 1}{z + 2}$$

45. **Ans: (b)**

Sol: $H(e^{j\omega}) = \frac{2e^{j\omega} + 1}{e^{j\omega} + 2}$

$$|H(e^{j0})| = 1$$

$$|H(e^{j\pi/2})| = 1$$

$$|H(e^{j\pi})| = 1$$

So, All pass filter

46. **Ans: (a)**

Sol: $1 - k[z^{-1} + z^{-2}] = 0$

$$z^2 - zk - k = 0$$

$$z_{1,2} = \frac{+k \pm \sqrt{k^2 + 4k}}{2}$$

For causal & stable $|\text{poles}| < 1$

$$k = 1 \Rightarrow z_{1,2} = \frac{1 \pm \sqrt{5}}{2} = \frac{1 \pm 2.236}{2}$$

(outside the unit circle)

$$k = 2 \Rightarrow z_{1,2} = \frac{2 \pm \sqrt{12}}{2} = 1 \pm \sqrt{3}$$

$$= 1 \pm 1.732$$

outside the unit circle

Here $k = [-1, 1/2]$

47.

Sol: $H(z) = \frac{-0.54 + z^{-1}}{1 - 0.54z^{-1}}$

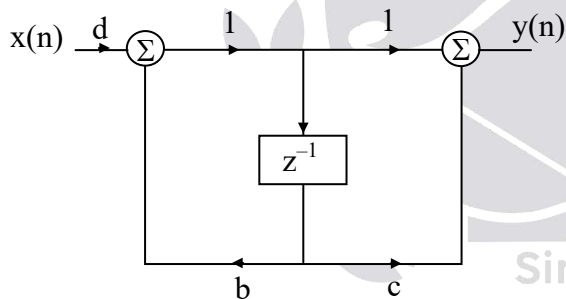

From the above block diagram

$$H(z) = \frac{d + dcz^{-1}}{1 - bz^{-1}}$$

By comparing

$$d = -0.54, c = -\frac{1}{0.54}, b = 0.54$$

48.

- Sol:**
- (a) All the finite poles of an FIR filter must lie at $z = 0$. True
 - (b) An FIR filter is always linear phase. False
 - (c) An FIR filter is always stable. True
 - (d) A causal IIR filter can never display linear phase. True
 - (e) A linear phase sequence is always symmetric about its midpoint. True
 - (f) A minimum phase filter (poles, zeros inside unit circle) is not linear phase. True
 - (g) An allpass filter can never display linear phase. True

Chapter 8 Digital Filter Design

01.

Sol:

$$(a) H(s) = \frac{1}{s+2}$$

$$H(s) = \frac{1}{s+a} \Rightarrow H(z) = \frac{1}{1 - e^{-aT_s} z^{-1}}$$

$$\text{Where } T_s = \frac{1}{F_s} = \frac{1}{2}$$

$$a = 2$$

$$H(z) = \frac{1}{1 - e^{-1} z^{-1}} = \frac{z}{z - e^{-1}}$$

$$(b) h(t) = e^{-2t} \cdot u(t)$$

$$h(nT_s) = e^{-2nT_s} u(nT_s) = e^{-n} \cdot u\left(\frac{n}{2}\right)$$

$$(c) Y(s) = H(s) \cdot X(s) = \frac{1}{s(s+2)} = \frac{\left(\frac{1}{2}\right)}{s} - \frac{\left(\frac{1}{2}\right)}{s+2}$$

$$y(t) = \frac{1}{2} [1 - e^{-2t}] u(t)$$

$$y(nT_s) = \frac{1}{2} [1 - e^{-n}] u\left(\frac{n}{2}\right)$$

04.

Sol: $H(s) = \frac{1}{s+a} \Rightarrow H(z) = \frac{1}{1 - e^{-aT_s} z^{-1}}$

$$f_s = 200 \text{ Hz}, f_c = 50 \text{ Hz}$$

$$\omega_c = \frac{2\pi f_c}{f_s} = \frac{\pi}{2}$$

$$H'(s) = H(s) \Big|_{s \rightarrow \frac{s}{\omega_c}} = \frac{s}{s+1.57}$$

$$H'(s) = \frac{1.57}{s+1.57}$$

$$H(z) = \frac{1.57}{1 - e^{-1.57(1)} z^{-1}} = \frac{1.57}{1 - 0.208z^{-1}}$$

If we want to match the gains of $H(s)$ at $s = 0$ and $H(z)$ at $z = 1$, the digital transfer function is extra multiplied by

$$\frac{1}{1.98} [H(z) \Big|_{z=1} = 1.98]$$

$$H(z) = \frac{1.57 \left(\frac{1}{1.98} \right)}{1 - 0.208z^{-1}}$$

05.

Sol:

$$(a) H(z) = H(s) \Big|_{s \rightarrow \frac{2 \left[\frac{1-z^{-1}}{1+z^{-1}} \right]}{T}}$$

$$T = \frac{1}{F_s} = \frac{1}{2}$$

$$H(z) = H(s) \Big|_{s=4 \left[\frac{1-z^{-1}}{1+z^{-1}} \right]}$$

$$H(z) = \frac{3}{\left[4 \left[\frac{1-z^{-1}}{1+z^{-1}} \right] \right]^2 + 3 \left[4 \left[\frac{1-z^{-1}}{1+z^{-1}} \right] \right] + 3}$$

$$H(z) = \frac{3[1+z^{-1}]^2}{16[1-z^{-1}]^2 + 12[1-z^{-2}] + 3[1+z^{-1}]^2}$$

(b) Gain of $H(s)$ at $\omega = 3$ is

$$H(j\omega) = \frac{3}{(j\omega)^2 + 3j\omega + 3}$$

$$|H(j\omega)| = \frac{3}{\sqrt{(3-\omega^2)^2 + (3\omega)^2}}$$

$$\begin{aligned} |H(j\omega)|_{\omega=3} &= \frac{3}{\sqrt{(3-9)^2 + (6)^2}} = \frac{3}{\sqrt{(6)^2 + (6)^2}} \\ &= \frac{3}{\sqrt{72}} = \frac{3}{6\sqrt{2}} = \frac{1}{2\sqrt{2}} = 2.828 \end{aligned}$$

Given $f = 20 \text{ Hz}$

$$\omega = \frac{2\pi \times f}{f_s} = \frac{2\pi \times 20 \text{ kHz}}{80 \text{ kHz}} = \frac{\pi}{2}$$

$$H(e^{j\omega}) = \frac{3(1+e^{-j\omega})^2}{16(1-e^{-j\omega})^2 + 12(1-e^{-2j\omega}) + 3(1+e^{-j\omega})^2}$$

$$H(e^{j\omega}) \Big|_{\omega=\frac{\pi}{2}} = \frac{3(1-j)^2}{16(1+j)^2 + 12(2) + 3(1-j)^2}$$

$$= \frac{3(-2j)}{16(2j) + 24 + 3(-2j)} = \frac{-6j}{26j + 24}$$

$$\left| H(e^{j\frac{\pi}{2}}) \right| = \frac{6}{\sqrt{(26)^2 + (24)^2}} = \frac{6}{35.38} = 0.169$$

06.
Sol:

$$(a) H(s) = \frac{s}{s^2 + s + 1}$$

$$H(j\omega) = \frac{j\omega}{-\omega^2 + j\omega + 1} = \frac{j\omega}{1 - \omega^2 + j\omega}$$

$$|H(j\omega)| = \frac{\omega}{\sqrt{(1 - \omega^2)^2 + \omega^2}}$$

ω	$ H(j\omega) $
0	0
∞	0

Band pass filter

07.
Sol: $\alpha_p = 1$ dB, $f_p = 4$ kHz

 $\alpha_s = 40$ dB, $f_s = 6$ kHz

 $F_S = 24$ kHz

Butterworth filter :

$$(1) \text{ order } N \geq \frac{\log \left[\frac{10^{0.1\alpha_s} - 1}{10^{0.1\alpha_p} - 1} \right]}{\log \left[\frac{\Omega_S}{\Omega_P} \right]}$$

$$\omega_p = \frac{2\pi \times f_p}{F_s} = \frac{2\pi \times 4}{24} = \frac{\pi}{3}$$

$$\omega_s = \frac{2\pi \times f_s}{F_s} = \frac{2\pi \times 6}{24} = \frac{\pi}{2}$$

$$\frac{\Omega_S}{\Omega_P} = \frac{\tan\left(\frac{\omega_S}{2}\right)}{\tan\left(\frac{\omega_P}{2}\right)} = \frac{\tan\left(\frac{\pi}{4}\right)}{\tan\left(\frac{\pi}{6}\right)} = \frac{1}{\frac{1}{\sqrt{3}}} = \sqrt{3}$$

$$N \geq \frac{\log \left[\frac{\sqrt{10^{0.1(40)} - 1}}{\sqrt{10^{0.1(1)} - 1}} \right]}{\log(\sqrt{3})} = \frac{\log \left[\frac{\sqrt{10^4 - 1}}{\sqrt{10^{0.1} - 1}} \right]}{\log(\sqrt{3})}$$

$$N \geq \frac{\log \left[\sqrt{\frac{9999}{1.258}} \right]}{\log(\sqrt{3})} = \frac{\log \left[\sqrt{7948.33} \right]}{\log(\sqrt{3})}$$

$$N \geq \frac{\log[89.15]}{\log(1.732)}$$

$$N \geq \frac{1.950}{0.238}$$

$$N \geq 8.19$$

$$N = 9$$

Chebyshev filter:

$$N \geq \frac{\cosh^{-1} \left[\frac{\sqrt{10^{0.1\alpha_s} - 1}}{\sqrt{10^{0.1\alpha_p} - 1}} \right]}{\cosh^{-1} \left[\frac{\Omega_S}{\Omega_P} \right]}$$

$$N \geq \frac{\cosh^{-1}[89.15]}{\cosh^{-1}[1.732]} = \frac{5.183}{1.146}$$

$$N \geq 4.52$$

$$N = 5$$

08.
Sol: $\alpha_p = 0.5$ dB, $f_p = 1.2$ kHz

 $\alpha_s = 40$ dB, $f_s = 2$ kHz

 $F_S = 8$ kHz

Butterworth filter:

$$\omega_p = \frac{2\pi f_p}{F_s} = \frac{2\pi \times 1.2}{8} = \frac{3\pi}{10}$$

$$\omega_s = \frac{2\pi f_s}{F_s} = \frac{2\pi \times 2}{8} = \frac{\pi}{2}$$

$$N \geq \frac{\log \left[\frac{\sqrt{10^{0.1\alpha_s} - 1}}{\sqrt{10^{0.1\alpha_p} - 1}} \right]}{\log \left[\frac{\Omega_S}{\Omega_P} \right]}$$

$$\frac{\Omega_s}{\Omega_p} = \frac{\tan\left(\frac{\omega_p}{2}\right)}{\tan\left(\frac{\omega_s}{2}\right)} = \frac{\tan\left(\frac{3\pi}{20}\right)}{\tan\left(\frac{\pi}{4}\right)} = 0.509$$

$$N \geq \frac{\log\left[\sqrt{\frac{10^{0.1(40)} - 1}{10^{0.1(1)} - 1}}\right]}{\log(1.964)}$$

$$N \geq \frac{3.949}{0.293}$$

$$N \geq 13.47$$

$$N = 14$$

Chebyshev filter:

$$N \geq \frac{\cosh^{-1}\left[\sqrt{\frac{10^{0.1\alpha_s} - 1}{10^{0.1\alpha_p} - 1}}\right]}{\cosh^{-1}\left[\frac{\Omega_s}{\Omega_p}\right]}$$

$$N \geq \frac{\cosh^{-1}[8911]}{\cosh^{-1}[1.964]} = \frac{9.788}{1.295}$$

$$N \geq 7.55$$

$$N = 8$$

09.

Sol:

$$\alpha_p = 1 \text{ dB}, \quad \omega_p = 0.3\pi$$

$$\alpha_s = 60 \text{ dB}, \quad \omega_s = 0.35\pi$$

Butter worth filter:

$$\text{order } N \geq \frac{\cosh^{-1}\left[\sqrt{\frac{10^{0.1\alpha_s} - 1}{10^{0.1\alpha_p} - 1}}\right]}{\cosh^{-1}\left[\frac{\Omega_s}{\Omega_p}\right]}$$

$$\frac{\Omega_s}{\Omega_p} = \frac{\tan\left(\frac{0.35\pi}{2}\right)}{\tan\left(\frac{0.3\pi}{2}\right)} = \frac{0.612}{0.509} = 1.202$$

$$N = \frac{\cosh^{-1}\left[\frac{10^6 - 1}{10^{0.1} - 1}\right]}{\cosh^{-1}[1.202]}$$

$$N = \frac{15.85}{0.625} = 25.36$$

$$N = 26$$

11.

$$\text{Sol: } z_1 = \frac{1}{2} e^{j\frac{\pi}{3}}$$

$$z_2 = z_1^* = \frac{1}{2} e^{-j\frac{\pi}{3}}$$

$$z_3 = z_1^{-1} = 2e^{-j\frac{\pi}{3}}$$

$$z_4 = [z_1^*]^{-1} = 2e^{j\frac{\pi}{3}}$$

12. Ans: (a)

$$\text{Sol: } H(z) = [1 + 2z^{-1} + 2z^{-2}] G(z)$$

Liner FIR has symmetry (or) anti symmetry

$$\text{So, } G(z) = 3 + 2z^{-1} + z^{-2}$$

$$H(z) = [1 + 2z^{-1} + 2z^{-2}] [3 + 2z^{-1} + z^{-2}]$$

$$= 3 + 8z^{-1} + 10z^{-2} + 8z^{-3} + 3z^{-4}$$

13.

$$\text{Sol: (a) } H(z) = 1 + z^{-2}$$

$$H(z)|_{z=1} = 2 \text{ Band stop filter type - I}$$

$$H(z)|_{z=-1} = 2$$

$$(b) H(z) = 1 + 2z^{-1} + 2z^{-2} + z^{-3}$$

$$H(z)|_{z=1} = 6 \text{ low pass filter type - II}$$

$$H(z)|_{z=-1} = 0$$

$$(c) H(z) = 1 - z^{-2}$$

$$H(z)|_{z=1} = 0 \text{ Band pass filter type - III}$$

$$H(z)|_{z=-1} = 0$$

$$(d) H(z) = -1 + 2z^{-1} - 2z^{-2} + z^{-3}$$

$$H(z)|_{z=1} = 0 \text{ High pass filter of type-IV}$$

$$H(z)|_{z=-1} = -6$$

14.

- Sol:** (a) $h(n) = [2, -3, 4, 1, 4, -3, 2]$
 (b) $h(n) = [2, -3, 4, 1, 1, 4, -3, 2]$
 (c) $h(n) = [2, -3, 4, 1, 0, 1, 4, 3, -2]$
 (d) $h(n) = [2, -3, 4, 1, -1, -4, 3, -2]$

16.

$$\text{Sol: } h_d(n) = \frac{1}{2\pi} \int_{-\frac{\pi}{4}}^{\frac{\pi}{4}} e^{-3j\omega} \cdot e^{j\omega n} d\omega = \frac{\sin \frac{\pi}{4}(n-3)}{\pi(n-3)}$$

n	$h_d(n)$	$\omega(n) = 0.54 - 0.48 \cos\left(\frac{2\pi n}{6}\right)$	$H(n) = h_d(n) \cdot \omega(n)$
0	0.075	0.08	$a = 6 \times 10^{-3}$
1	0.159	0.31	$b = 0.049$
3	1/4	1	$c = 0.173$
4	0.225	0.77	$d = 0.25$
5	0.159	0.31	$c = 0.173$
6	0.075	0.08	$b = 0.049$ $a = 6 \times 10^{-3}$

$$H(z) = \sum_{n=0}^6 h(n)z^{-n}$$

$$= a[1+z^{-6}] + b[z^{-1}+z^{-5}] + c[z^{-2}+z^{-4}] + dz^{-3}$$

Since 1995

ACE

Chapter 9

DFT & FFT

01.

Sol: $\Delta F = \frac{F_s}{N} = \frac{10 \times 10^3}{1024}$

02.

Sol:
$$\begin{bmatrix} 1 & 1 & 1 & 1 \\ 1 & -j & -1 & j \\ 1 & -1 & 1 & -1 \\ 1 & j & -1 & -j \end{bmatrix} \begin{bmatrix} 0 \\ 1 \\ 2 \\ 3 \end{bmatrix} = \begin{bmatrix} 6 \\ -2 + 2j \\ -2 \\ -2 - 2j \end{bmatrix}$$

$X(k) = \{6, -2 + 2j, -2, -2 - 2j\}$

03.

Sol: i) $X(K) = \sum_{n=0}^{N-1} x(n) e^{-j \frac{2\pi}{N} nk}$

$X(0) = \sum_{n=0}^{N-1} x(n)$

Given $x(n) = -x(N-1-n)$

$n = 0 \Rightarrow x(0) = -x(N-1)$

$n = 1 \Rightarrow x(1) = -x(N-2)$

$X(0) = x(0) + x(1) + \dots + x(N-3)$

$+ x(N-2) + x(N-1)$

From the given condition $x(0)$ and $x(N-1)$ Cancel each other. In the same way $x(1)$ and $x(N-2)$ cancel each other.

So finally all the terms will cancel and becomes zero.

ii) $x(n) = x(N-1-n)$

$X\left(\frac{N}{2}\right) = \sum_{n=0}^{N-1} x(n) e^{-j \frac{2\pi}{N} \frac{N}{2} n}$

$= \sum_{n=0}^{N-1} x(n) e^{j\pi n}$

$= \sum_{n=0}^{N-1} x(n) (-1)^n$

$= x(0) - x(1) + x(2) + \dots - x(N-3) + x(N-2) - x(N-1)$

Given condition is $x(n) = x(N-1-n)$

$n = 0 \Rightarrow x(0) = x(N-1)$

$n = 1 \Rightarrow x(1) = x(N-2)$

From given condition, $x(0)$, $x(N-1)$ cancel each other.

$x(1)$, $x(N-2)$ cancel each other. Finally all the terms vanishes and becomes zero.

04.

Sol: $x(n) = \{6, 5, 4, 3\}$

a. $x([n-2])_4 = \{4, 3, 6, 5\}$

b. $x([n+1])_4 = \{5, 4, 3, 6\}$

c. $x([-n])_4 = \{6, 3, 4, 5\}$

05.

Sol: If $x(n)$ is real $X(k) = X^*(N-k)$

$X(5) = X^*(3) = 0.125 + j0.0518$

$X(6) = X^*(2) = 0$

$X(7) = X^*(1) = 0.125 + j0.3018$

06. Ans: (a)

Sol: $[p \ q \ r \ s] = [a \ b \ c \ d] \otimes [a \ b \ c \ d]$

DFT of $[p \ q \ r \ s] = [\alpha \ \beta \ \gamma \ \delta]$. $[\alpha \ \beta \ \gamma \ \delta]$

DFT of $[p \ q \ r \ s] = [\alpha^2 \ \beta^2 \ \gamma^2 \ \delta^2]$

07.

Sol: (a) $X(0) = \sum_{n=0}^5 x(n) = -3$

(b) $Nx(0) = 6 \times 1 = 6$

(c) $\sum_{n=0}^5 (-1)^n x(n) = 21$

(d) $N \left[\sum_{n=0}^5 |x(n)|^2 \right] = 546$

(e) $Nx(3) = 6(-4) = -24$

08. Ans: (a)

Sol: $X(k) = X^*(N-k)$

$$X(1) = X^*(5) = 1 + j1$$

$$X(4) = X^*(2) = 2 - j2$$

$$x(0) = \frac{1}{6} \sum_{k=0}^5 X(k) = \frac{18}{6} = 3$$

09.

Sol:

(i) According to given signals we can say

$$x_2(n) = x_1(n-4)$$

$$X_2(K) = X_1(K) e^{-j \frac{2\pi}{8} \cdot 4K}$$

$$X_2(K) = e^{-j\pi K} X_1(K)$$

$$X_2(K) = (-1)^K X_1(K)$$

(ii) $Y(k) = e^{-j \frac{2\pi}{6} 4k}$

$$y(n) = x((n-4))_6 = \{2, 1, 0, 0, 4, 3\}$$

10.

Sol: $x(n) = \frac{1}{N} \sum_{k=0}^{N-1} X(k) e^{j \frac{2\pi}{N} nk}$, $n = 0$ to $N-1$

11.

Sol: (a) $\Delta f = \frac{f_s}{N} = \frac{20 \times 10^3}{10^3} = 20$

(b) For $k = 150$, $f = 20 \times 150 = 3 \text{ kHz}$

For $k = 800$, $f = (16 - 20) \text{ kHz} = -4 \text{ kHz}$

12. Ans: (a)

Sol: $Q(K)$ – 3 point DFT

$$q(n) = \frac{1}{N} \sum_{K=0}^{N-1} Q(K) e^{j \frac{2\pi nK}{N}}$$

$$n = 0$$

$$q(0) = \frac{1}{3} \sum_{K=0}^2 Q(K) = \frac{Q(0) + Q(1) + Q(2)}{3}$$

$$Q(0) = X(0), Q(1) = X(2), Q(2) = X(4)$$

$$Q(0) = X(0) = \sum_{n=0}^{N-1} x(n)$$

$$= \sum_{n=0}^5 x(n) = 4 + 3 + 2 + 1 = 10$$

$$Q(1) = X(2) = \sum_{n=0}^5 x(n) \cdot e^{-j \frac{2\pi n(2)}{6}}$$

$$= \sum_{n=0}^5 x(n) e^{-j \frac{2\pi n}{3}}$$

$$= x(0) + x(1) e^{-j \frac{2\pi}{3}} + x(2) e^{-j \frac{4\pi}{3}} + x(3) e^{-j 2\pi}$$

$$= 4 + 3 \left[\frac{-1}{2} - j \frac{\sqrt{3}}{2} \right] + 2 \left[\frac{-1}{2} + j \frac{\sqrt{3}}{2} \right] + 1$$

$$= 4 - \frac{3}{2} - \frac{j3\sqrt{3}}{2} - 1 + \frac{2j\sqrt{3}}{2} + 1$$

$$Q(1) = \frac{5}{2} - \frac{\sqrt{3}}{2} j$$

$$Q(2) = X(4) = \sum_{n=0}^5 x(n) e^{-j \frac{2\pi n(4)}{6}}$$

$$= \sum_{n=0}^5 x(n) e^{-j \frac{4\pi n}{3}}$$

$$Q(2) = x(0) + x(1) e^{-j \frac{4\pi}{3}} + x(2) e^{-j \frac{8\pi}{3}}$$

$$+ x(3) e^{-j \frac{4\pi(3)}{3}}$$

$$= 4 + 3 \left[\frac{-1}{2} + j \frac{\sqrt{3}}{2} \right] + 2 \left[\frac{-1}{2} - j \frac{\sqrt{3}}{2} \right] + x(3) \cdot (1)$$

$$= 4 - \frac{3}{2} + \frac{j\sqrt{3}(3)}{2} - 1 - j \frac{2}{2} \sqrt{3} + 1$$

$$= \frac{5}{2} + \frac{\sqrt{3}}{2} j$$

$$q(0) = \frac{10 + \frac{5}{2} - \frac{\sqrt{3}}{2} j + \frac{5}{2} + \frac{\sqrt{3}}{2} j}{3} = \frac{15}{3} = 5$$

13.

Sol: $X(0) = \sum_{n=0}^7 x(n) = A + B + 27 = 20$

$A+B = -7$ -----(1)

$X(4) = \sum_{n=0}^7 (-1)^n x(n)$

$X(4) = A - 2 + 3 - 4 + 5 - 6 + 7 - B = 0$

$A-B = -3$ ------(2)

From (1) and (2)

$A = -5, B = -2$

14. **Ans: 3**

Sol: $X(k) = k + 1$ for $0 \leq k \leq 7 \rightarrow$ 8pt DFT of $x(n)$

Using Signal Flow Graph of IDFT based on inverse radix-2 DIT-FFT

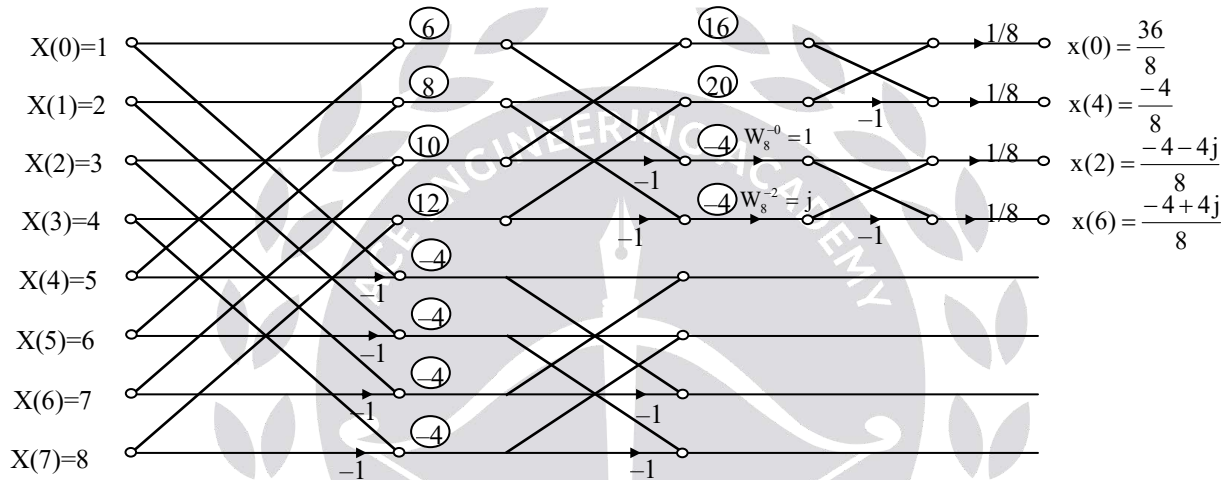

Value of $\sum_{n=0}^3 x(2n) = x(0) + x(2) + x(4) + x(6) = \frac{36 - 4 - 4 - 4j - 4 + 4j}{8} = \frac{24}{8} = 3$

Since 1995 **OR**



$X(k) = k + 1 \quad 0 \leq k \leq 7$

$X(k) = \sum_{n=0}^{N-1} x(n) e^{-j\frac{2\pi}{N}nk} \quad X(k) = \sum_{n=0}^{\frac{N}{2}-1} x(2n) e^{-j\frac{2\pi}{N}(2n)k} + \sum_{n=0}^{\frac{N}{2}-1} x(2n+1) e^{-j\frac{2\pi}{N}(2n+1)k}$

$X(k) = \sum_{n=0}^{\frac{N}{2}-1} x(2n) e^{-j\frac{2\pi}{N}(2n)k} + e^{-j\frac{2\pi}{N}k} \sum_{n=0}^{\frac{N}{2}-1} x(2n+1) e^{-j\frac{2\pi}{N}(2n)k}$

Given $N = 8$

$X(k) = \sum_{n=0}^3 x(2n) e^{-j\frac{2\pi}{8}(2n)k} + e^{-j\frac{\pi}{4}k} \sum_{n=0}^3 x(2n+1) e^{-j\frac{2\pi}{8}(2n)k}$

$$X(0) = \sum_{n=0}^3 x(2n) + \sum_{n=0}^3 x(2n+1)$$

$$X(4) = \sum_{n=0}^3 x(2n)e^{-j2\pi n} + e^{-j\pi} \sum_{n=0}^3 x(2n+1)e^{-j2\pi n}$$

$$X(4) = \sum_{n=0}^3 x(2n) - \sum_{n=0}^3 x(2n+1)$$

$$X(0) + X(4) = 2 \sum_{n=0}^3 x(2n)$$

$$\sum_{n=0}^3 x(2n) = \frac{X(0) + X(4)}{2} = \frac{1+5}{2} = \frac{6}{2} = 3$$

15.

Sol: (A) For 8 point DFT, value at $n = 9$ means value at $n = 1$
we know

$$x(n) = \frac{1}{N} \sum_{K=0}^{N-1} X(K) e^{j\left(\frac{2\pi}{N}\right)Kn}$$

$$\frac{1}{8} \sum_{K=0}^7 X(K) e^{j\left(\frac{2\pi}{N}\right)K \cdot 1} = x(1)$$

(B) $W(K) = X(K) + X(K+4)$

$$W(K) = X(K) + X\left(K + \frac{N}{2}\right)$$

$$w(n) = x(n) + (-1)^n x(n)$$

(C) $Y(K) = 2 X(K) \quad K = 0, 2, 4, 6$
 $= 0 \quad K = 1, 3, 5, 7$

$$\Rightarrow Y(K) = X(K) + (-1)^K X(K)$$

$$\Rightarrow y(n) = x(n) + x\left(n - \frac{N}{2}\right)$$

16. **Ans: (a)**

Sol: $W(k) = X(k) \cdot Y(k) = [176, 12+4j, 0, 12-4j]$

$$w(2) = \frac{-1}{N} \sum_{k=0}^3 (-1)^k \cdot W(k) = \frac{152}{4} = 38$$

17.

Sol:

(i) $f_s = 10\text{Hz}$

$$\text{Sampling Period } (T_s) = \frac{1}{f_s} = \frac{1}{10} = 0.1\text{sec}$$

Time index for $x(3)$ is 3

$$\text{Sampling instant for } x(3) = 3(0.1) = 0.3\text{ sec}$$

(ii) Frequency Resolution = $\frac{f_s}{N} = \frac{10}{4} = 2.5\text{ Hz}$

Frequency bin number for $X(1)$ and $X(3)$ are 1 and 3 respectively.

Frequency for $X(1)$ and $X(3)$ are 2.5 Hz and 7.5 Hz

18.

Sol: $f_m = 100\text{ Hz}$

$$f_s = 200\text{ Hz}$$

$$\Delta f \leq 0.5\text{ Hz}$$

(a) DFT $\Delta f = \frac{f_s}{N}$

$$N = \frac{f_s}{\Delta f} = \frac{200}{0.5} = 400$$

(b) radix-2FFT

$$N = 2^9 = 512\text{ samples (at } N = 400)$$

$$\Delta f = \frac{200}{512} = 0.39\text{ Hz}$$

19.
Sol:

$$f_1 = 25, f_2 = 100, f_s = 800\text{Hz}$$

$$(a) N = 100 \text{ samples}$$

$$\Delta f = \frac{f_s}{N} = \frac{800}{8} = 8\text{Hz}$$

$$25\text{Hz corresponding to } \frac{25}{8} = 3.125$$

$$100 \text{ Hz corresponding to } \frac{100}{8} = 12.5$$

Both frequencies are not relating.

$$(b) N = 128$$

$$\Delta f = \frac{800}{128} = 6.25\text{Hz}$$

$$25\text{Hz} \rightarrow \frac{25}{6.25} = 4$$

$$100 \text{ Hz} \rightarrow \frac{100}{6.25} = 16$$

20.

$$\text{Sol: } X(k) = [1, -2, 1 - j, j2, 0, \dots]$$

$$(a) X(k) = X^*(N - k)$$

$$X(5) = X^*(8 - 5) = X^*(3) = -j2$$

$$X(6) = X^*(2) = 1 + j$$

$$X(7) = X^*(1) = -2$$

$$(b) y(n) = (-1)^n x(n)$$

 $Y(k) = X(k - 4)$ last four sample will shifted to beginning

$$(c) g(n) = x\left(\frac{n}{2}\right)$$

Zero interpolation in time domain corresponds to replication of the DFT spectrum

21. Ans: 6
Sol: Interpolation in time domain equal to replication in frequency domain.

$$x_1(n) = x\left(\frac{n}{3}\right)$$

$$X_1(k) = [12, 2j, 0, -2j, 12, 2j, 0, -2j, 12, 2j, 0, -2j]$$

$$X_1(8) = 12, X_1(11) = -2j$$

$$\left| \frac{X_1(8)}{X_1(11)} \right| = \left| \frac{12}{-2j} \right| = 6$$

22.
Sol:

$$(a) t = 1\mu\text{s}$$

 $N = 1024$, total time to perform multiplication using DFT directly

$$= (1024)^2 \times 1\mu\text{s} = 1.05 \text{ sec}$$

$$(b) \text{ by FFT, } T = \left[\frac{N}{2} \log_2 N \right] 1\mu\text{s}$$

$$= \left[\frac{1024}{2} \log_2 1024 \right] 1\mu\text{s} \\ = 5.12 \text{ msec}$$

23. Ans: 61.44 ms

$$\text{Sol: } f_s = 10 \text{ kHz}, N = 1024, \Delta f = \frac{f_s}{N}$$

Over all time required for processing the

$$\text{entire data} = \frac{N}{f_s} = \frac{1024}{10 \times 10^3} = 102.4 \text{ msec}$$

Complex multiplications = 4 times real multiplications

 With a radix - 2 FFT, the number of complex multiplications for a 1024 point DFT is approximately $512 \log_2 1024 = 5120$.

 this means we have to perform $5120 \times 4 = 20480$ real multiplications for the DFT and the same number of for IDFT. With $1\mu\text{s}$ per multiplication, this will take $t = 2 \times 20480 \times 10^{-6} = 40.96 \text{ ms}$.

 The time remaining after DFT and IDFT is $102.4 - 40.96 = 61.44 \text{ ms}$.